

Appendix A

MODELING FRAMEWORK

The computational framework chosen for the modeling of water quality of the Still Pond Creek was the Water Quality Analysis Simulation Program version 5.1 (WASP5.1). This program provides a generalized framework for modeling contaminant fate and transport in surface waters (Di Toro *et al.*, 1983) and is based on the finite-segment approach. It is a very versatile program, capable of being applied in a time-variable or steady-state mode, spatial simulation in one, two or three dimensions, and using linear or non-linear estimations of water quality kinetics. To date, WASP5.1 has been employed in many modeling applications that have included river, lake, estuarine, and ocean environments. The model has been used to investigate water quality concerns regarding dissolved oxygen, eutrophication, and toxic substances. WASP5.1 has been used in a wide range of applications by regulatory agencies, consulting firms, academic researchers, and others.

WASP5.1 is supported and distributed by U.S. EPA's Center for Exposure Assessment Modeling (CEAM) in Athens, GA (Ambrose *et al.*, 1993). EUTRO5.1 is the component of WASP5.1 that is applicable for modeling eutrophication, incorporating eight water quality constituents in the water column (Figure A1) and sediment bed.

WATER QUALITY MONITORING

MDE's Field Operations Program staff collected physical and chemical samples on March 18, April 12, May 10, July 19, August 16, and September 13, 1999. The physical parameters, dissolved oxygen, salinity, conductivity, and water temperature, were measured *in situ* at each water quality monitoring station. Grab samples were also collected for laboratory analysis. The samples were collected at a depth of ½ m from the surface. Samples were placed in plastic bottles and preserved on ice until they were delivered to the University of Maryland Laboratory in Solomons, MD or to the Department of Health & Mental Hygiene in Baltimore, MD for analysis. The field and laboratory protocols used to collect and process the samples are summarized in Table A1. The March and May data were used to calibrate the water quality model of the Still Pond Creek during high flow conditions, and the July and August data were used to calibrate the water quality model during low flow conditions. April and September data were not used for the calibration of the model for reasons explained below. Figures A2 – A6 present low flow and high flow water quality profiles along the creek.

INPUT REQUIREMENTS ¹

Model Segmentation and Geometry

The spatial domain of the Still Pond Creek Eutrophication Model (SPCEM) extends from the confluence of the Chesapeake Bay and the Still Pond Creek for about 6.5 miles to the creek's headwaters near the intersection of Maryland's routes 298, 561 and 292 (near Lynch). Following a review of the bathymetry for Still Pond Creek, the model was divided into 20 segments. Figure A7 shows the model segmentation for the development of the SPCEM. Table A2 lists the volumes, characteristic lengths, and interfacial areas of the 20 segments.

Dispersion Coefficients

The dispersion coefficients were calibrated using the WASP5.1 model and in-stream water quality data from 1999. The WASP5.1 model was set up to simulate salinity. Salinity is a conservative constituent, which means there are no losses due to reactions in the water. The only source in the system is at the tidal boundary at the mouth of the creek. For the model execution, salinities at all boundaries except the tidal boundary were set to zero. Flows were obtained from three USGS gages near the basin (see the following section on freshwater flows for more detail). Because of the narrow constriction at the Still Pond Creek's confluence zone, the salinity distribution is unusual throughout the river. Only July and August salinity data was used for the calibration of the low flow dispersion coefficients, because the temperature data of September were greatly different from the July and August temperature data. March and May salinity data was used for the calibration of the high flow dispersion coefficients, because the April data was collected on a rainy day and the data was very different when compared to the month of March and May. Figure A8 shows the results of the calibration of the dispersion coefficients for low flow. Dispersion coefficients are listed in Table A3.

Freshwater Flows

Freshwater flows were calculated on the basis of delineating the Still Pond Creek drainage basin into thirteen subwatersheds (Figure A9). These subwatersheds closely correspond to the Maryland Department of Natural Resources 12-digit basin codes. As necessary, the subwatersheds were refined to assure they were consistent with the 20 segments developed for the SPCEM. The SPCEM was calibrated for two sets of flow conditions: high flow and low flow. The high flow corresponds to the months of March, April, and May while the low flow corresponds to the months of July, August, and September. Again, September data was unsuitable for the calibration of the low flow model and April data was unsuitable for the high flow model calibration.

¹ The WASP model requires all input data to be in metric units, and to be consistent with the model, all data in the Appendix will appear in metric units except the stream length. Following are several conversion factors to aid in the comparison of numbers in the main document: $\text{mgd} \times (0.0438) = \text{m}^3/\text{s}$ | $\text{cfs} \times (0.0283) = \text{m}^3/\text{s}$ | $\text{lb} / (2.2) = \text{kg}$ | $\text{mg/l} \times \text{mgd} \times (8.34) / (2.2) = \text{kg/d}$ |

The high flows for the subwatersheds were estimated using an average flow from the months of (March, April, and May of 1999 from the USGS gages #01493000, #01493112, and #01493500 located near the Still Pond Creek Basin. A ratio of flow to drainage area was calculated and then multiplied by the area of the subwatersheds to obtain the high flows. During high flow, each subwatershed was assumed to contribute a flow to the Still Pond Creek, except subwatershed 13 that does not discharge into the modeling domain of the creek (see Figure A7, model segmentation).

The low flows for the subwatersheds were also estimated based on the flow to drainage area ratio of the three USGS gages as described above, but using flow data from the months of July 1 to September 15, 1999. Also, as in high flow, it was assumed that during summer, each subwatershed was assumed to contribute a flow to the Still Pond Creek, except subwatersheds 9 and 13.

The baseline low flows for the subwatersheds were also estimated based on the flow to drainage area ratio of the three USGS gages as described above, but using 7Q10 flow data. The 7Q10 flow is the 7-day consecutive lowest flow expected to occur every 10 years. Also, as in low flow, it was assumed that each subwatershed contributes a flow to the Still Pond Creek, except subwatersheds 9 and 13.

The average flows were also estimated based on the flow to drainage area ratio of the three USGS gages. The average flow was calculated using the flow data from March to September 1999. Table A4 presents the flows for the subwatersheds during high flow, low flow, low flow baseline, and average flows.

Point and Nonpoint Source Loadings

There are no point sources contributing loads to the Still Pond Creek. Nonpoint source loadings were estimated for low flow, high flow, and average annual flow conditions. Loads for low-flow and high-flow conditions were calculated from the product of observed concentrations and the respective estimated flows. These loads account for all sources because they are observed loads.

Concentrations for the determination of loads for the calibration of the model for both high flow and low flow were calculated using in-stream data from various monitoring stations within the Still Pond Creek basin and Worton Creek basin. Data from station XJH0516, located near the confluence of the Still Pond Creek with the Chesapeake Bay, was used as the boundary concentration for segment one, and data from station XIH9816 was used as a boundary concentration for segment three. Station MLQ0025 in Worton Creek was used for the remaining boundaries' concentrations, due to insufficient data available from Still Pond Creek. These stations were assumed to reasonably represent water quality for the boundaries with the available data within the Still Pond Creek and Worton Creek drainage basins.

Average annual loads were determined using all the data collected by MDE Field Office in 1999. An average of the March, April, May, July, August and September for each station was

FINAL

calculated, and the boundary concentrations were assigned in the same way as described above for high and low flow. These loads reflect both natural and human sources, including atmospheric deposition, loads coming from septic tanks, and loads stemming from urban development, agriculture, and forestland.

For nonpoint sources, the concentrations of the nutrients nitrogen and phosphorus are modeled in their speciated forms. The WASP5.1 model simulates nitrogen as ammonia (NH₃), nitrate and nitrite (NO₂₃), and organic nitrogen (ON); and phosphorus as ortho-phosphate (PO₄) and organic phosphorus (OP). Ammonia, nitrate and nitrite, and ortho-phosphate represent the dissolved forms of nitrogen and phosphorus. The dissolved forms of nutrients are more readily available for biological processes, such as algae growth, that can affect chlorophyll *a* levels and dissolved oxygen concentrations. The ratios of total nutrients to dissolved nutrients used in the model scenarios represent values that have been measured in the field.

Environmental Conditions

Eight environmental parameters were used for developing the model of the Still Pond Creek: solar radiation and photoperiod (see Table A5), temperature (T), extinction coefficient (K_e) and salinity, sediment oxygen demand (SOD), sediment ammonia flux (FNH₄), and sediment phosphate flux (FPO₄) (see Table A6).

Data for the solar radiation and photoperiod were taken from a water quality modeling study performed on the Potomac River on 1982 (HydroQual, 1982). Data for salinity and temperature were taken from in-stream water quality measurements. Initial values of SOD, FNH₄ and FPO₄ were estimated then refined through the calibration of the model.

The light extinction coefficient, K_e, in the water column was derived from Secchi depth measurements using the following equation:

$$K_e = \frac{1.95}{D_s}$$

where:

K_e = light extinction coefficient (m⁻¹)
D_s = Secchi depth (m)

It was estimated that nonliving organic nutrient components as well as phytoplankton settle from the water column into the sediment at an estimated settling rate velocity of 0.173 m/day or (2E10⁻⁶ m/sec). In general, it is reasonable to assume that between 40% and 50% of the nonliving organic nitrogen, organic phosphorus, and BOD, are in the particulate form. Such assignments were borne out through model sensitivity analyses.

Different SOD values were estimated for different SPCEM reaches based on observed environmental conditions and literature values (Institute of Natural Resource, 1986). A maximum SOD value of 1.0 g O₂/m²day was used.

Kinetic Coefficients

The water column kinetic coefficients are universal constants used in the SPCEM model. They are formulated to characterize the kinetic interactions among the water quality constituents. The initial values were taken from past modeling studies of the Potomac River (Clark and Roesh, 1978; Thomann and Fitzpatrick, 1982; Cerco, 1985), and of Mattawoman Creek (Panday and Haire, 1986, Domotor *et al.*, 1987), and the Patuxent River (Lung, 1993). The kinetic coefficients are listed in Table A7.

Initial Conditions

The initial conditions used in the model were chosen to reflect the observed values as closely as possible. However, it was found that initial conditions did not impact the final results.

CALIBRATION & SENSITIVITY ANALYSIS

The EUTRO5.1 model for low flow was calibrated with July and August 1999 data. Tables A8 – A10 show the nonpoint source flows and loads associated with the calibration input files. Figures A10-A17 show the results of the low flow calibration of the model. As can be seen in the figures, the model did a good job of capturing the general trend of almost all the state variables. The model did an excellent job of capturing both the peak concentrations and trends of chlorophyll *a*, dissolved oxygen, and nitrate. It was also able to replicate the ammonia, organic nitrogen, organic phosphorus, ortho-phosphate and BOD trends.

The EUTRO5.1 model for high flow was calibrated with March and May 1999 data. The results are presented in Figure A18-A25. As can be seen, the model captured the trends of almost all of the state variables. The model did a good job of capturing the trends of chlorophyll *a*, and ortho-phosphate.

SYSTEM RESPONSE

The EUTRO5.1 model of Still Pond Creek was applied to several different nonpoint source loading conditions under various stream flow conditions to project the impacts of nutrients on algal production, represented by chlorophyll *a*, and low dissolved oxygen. By simulating various stream flows, the analysis accounts for seasonality.

Model Run Descriptions

Baseline Condition Scenarios

First scenario (Low Flow): represents the expected conditions of the creek under current loading conditions during low flow. The baseline low flow was estimated using three USGS gages near the basin as described above with 7Q10 flow data. The total nonpoint source loads were

computed as the product of observed 1999 base-flow concentrations and the estimated low flow. These loads account for all background and human-induced sources because they are based on observed concentrations. All environmental parameters used for scenario 1 remained the same as used for the low flow calibration.

Second scenario (Average Annual Flow): represents the expected conditions of the creek during average flow. The average annual flow was estimated based on data from three USGS gages near the Still Pond Creek basin as described above. Nonpoint source load estimation methods, based on MDE 1999 observed data, are described above. All the environmental parameters, except the water temperature, remained the same. A summer average temperature of 26.1 °C was used for all segments, it was estimated based on historical water temperature for the month of July, August and September for the years 1985 to 2000 from two locations near the Still Pond Creek. They are the Elk River and the Chester River. The initial condition values were assumed to be the same as for Scenario 1. The nonpoint source loads for model Scenario 1 and Scenario 2 can be seen in Table A11 and Table A12 respectively.

Future Condition Scenario

A number of iterative model scenarios involving nutrient reductions were explored to determine the maximum allowable loads. The third and fourth scenarios show the water quality responses in the creek for the maximum allowable loads for low flow and average annual flow, respectively. To estimate feasible nitrogen and phosphorus nonpoint source reductions, the percent of the load that is controllable was estimated for each subwatershed. It was assumed that the loads stemming from cropland, feedlots, and urban areas were controllable and that loads from atmospheric deposition, septic tanks, pasture, and forest were not controllable. This analysis was performed on the average annual loads only because data for loads contributed by specific land uses were not available for low flow. The percent controllable, however, was applied to both the low flow loads and the average annual loads.

For the scenario runs where the nutrient loads to the system were reduced, a method was developed to estimate the reductions in nutrient fluxes and SOD from the sediment layer. First, for each segment, an initial estimate was made of the total organic nitrogen and organic phosphorus settling to the stream bottom from particulate nutrient organics, living algae, and phaeophytin. This was done by running the base-line condition scenario once with estimated settling of organics and chlorophyll *a* and again with no settling. The difference in the organic matter between the two runs was assumed to settle to the stream bottom where it would be available as a source of nutrient flux and SOD. All phaeophytin was assumed to settle to the bottom. The amount of phaeophytin was estimated from in-stream water quality data. To calculate the organic loads from the algae, it was assumed that the nitrogen to chlorophyll *a* ratio was 12.5 and that the phosphorus to chlorophyll *a* ratio was 1.25. This analysis was then repeated for the reduced nutrient loading conditions. The percentage difference between the amount of nutrients that settled in the base-line condition scenarios and the amount that settled in the reduced loading scenarios was then applied to the nutrient fluxes in each segment. The reduced nutrient scenarios were then run again with the updated fluxes. A new value of settled organics was calculated, and the fluxes were updated. The process was repeated until the reduced fluxes remained constant.

Along with reductions in nutrient fluxes from the sediments, when the nutrient loads to the system are reduced, the sediment oxygen demand will also be reduced (US EPA, 1997). It was assumed that the SOD would be reduced in the same proportion as the nitrogen fluxes, to a minimum of $0.6 \text{ gO}_2/\text{m}^2 \text{ day}$.

Third scenario (Low Flow): represents improved conditions associated with the maximum allowable loads to the stream during critical low flow. The flow was the same as in the first scenario. A margin of safety of 5% was included in the load calculation. The nitrogen and phosphorus loads were reduced from the first scenario (baseline scenario) to meet the chlorophyll *a* goal of $50 \text{ }\mu\text{g/l}$ and the dissolved oxygen criterion of no less than 5.0 mg/l . All environmental parameters and kinetic coefficients used for the calibration of the model (except nutrient fluxes and SOD) remained the same as in the first scenario. The nonpoint source loads for model scenario 3 can be seen in Table A13.

Fourth scenario (Average Annual Flow): represents improved conditions associated with the maximum allowable loads to the stream during average annual flow. The flow was the same as in the second scenario. The nitrogen and phosphorus loads were reduced from the second scenario (average annual flow baseline scenario) to meet chlorophyll *a* and dissolved oxygen standards in the same way as in the third scenario. A 3% margin of safety was included in the load calculation. All environmental parameters and kinetic coefficients used for the calibration of the model (except nutrient fluxes and SOD) remained the same as in the second scenario. The nonpoint source loads for model scenario 4 can be seen in Table A14.

Scenario Results

Baseline Loading Condition Scenarios

First Scenario (Low Flow): Simulates critical low stream flow conditions during summer season. Water quality parameters (e.g., nutrient concentrations) are based on 1999 observed data. Results for this scenario, which represents base-line summer low flow conditions, are summarized in Figures A26-A33. As can be seen, the peak chlorophyll *a* level is above the desired threshold value of $50 \text{ }\mu\text{g/l}$, reaching a maximum value of about $73 \text{ }\mu\text{g/l}$. The dissolved oxygen concentrations remain above the minimum water quality criterion of 5 mg/l throughout the creek.

Second Scenario (Average Annual Flow): Simulates average stream flow conditions, with average annual nonpoint source loads estimated based on all MDE observed data collected in 1999. Results for this scenario, which represents base-line conditions for average stream flow and loads, are summarized in Figures A34-A41. Under these conditions, the chlorophyll *a* concentrations are also above the desired threshold value of $50 \text{ }\mu\text{g/l}$ with a maximum close to $84 \text{ }\mu\text{g/l}$, but the dissolved oxygen concentrations remain above the 5 mg/l criterion throughout the creek.

The SPCEM calculates the daily average dissolved oxygen concentrations in the stream. This is not necessarily protective of water quality when one considers the effects of diurnal dissolved oxygen variation due to photosynthesis and respiration of algae. The photosynthetic process centers about the chlorophyll containing algae that utilize radiant energy from the sun to convert water and carbon dioxide into glucose and release oxygen. The production of oxygen proceeds only during daylight hours because the photosynthetic process is dependent on solar radiant energy. Concurrently with this production, however, the algae require oxygen for respiration, which can be considered to proceed continuously. Minimum values of dissolved oxygen usually occur in the early pre-dawn hours when the algae have been without light for the longest period of time, whereas maximum values of dissolved oxygen usually occur in the early afternoon. The diurnal range (maximum minus minimum) may be large, and if the daily mean level of dissolved oxygen is low, minimum values of dissolved oxygen during a day may approach zero and hence create a potential for fish kill. The diurnal dissolved oxygen variation due to photosynthesis and respiration is calculated by the SPCEM based on the amount of chlorophyll *a* in the water. For the rest of the model results, the minimum dissolved oxygen concentration is reported.

Future Condition TMDL Scenarios:

Third Scenario (Low flow): Simulates the future condition of maximum allowable loads for critical low stream flow conditions during the summer season, as described above in the descriptions section. The results of this scenario (solid line), which represents the maximum allowable loads for summer low flow conditions, are shown in Figures A42-A49 in comparison to the corresponding base-line scenario (dotted line). It can be seen that under the nutrient load reduction conditions, the water quality targets for dissolved oxygen and chlorophyll *a* are satisfied at all locations in the Still Pond Creek.

Fourth Scenario (Average Annual Flow): Simulates the future condition of maximum allowable loads under average stream flow and average annual loading conditions. The results for this scenario (solid line), which represents the maximum allowable loads for average annual flow, are summarized and compared to the corresponding base-line flow (dotted line) in Figures A50-A57. Again the water quality criteria for dissolved oxygen (greater than 5 mg/l) and chlorophyll *a* (less than 50 µg/l) are met for the entire length of the creek.

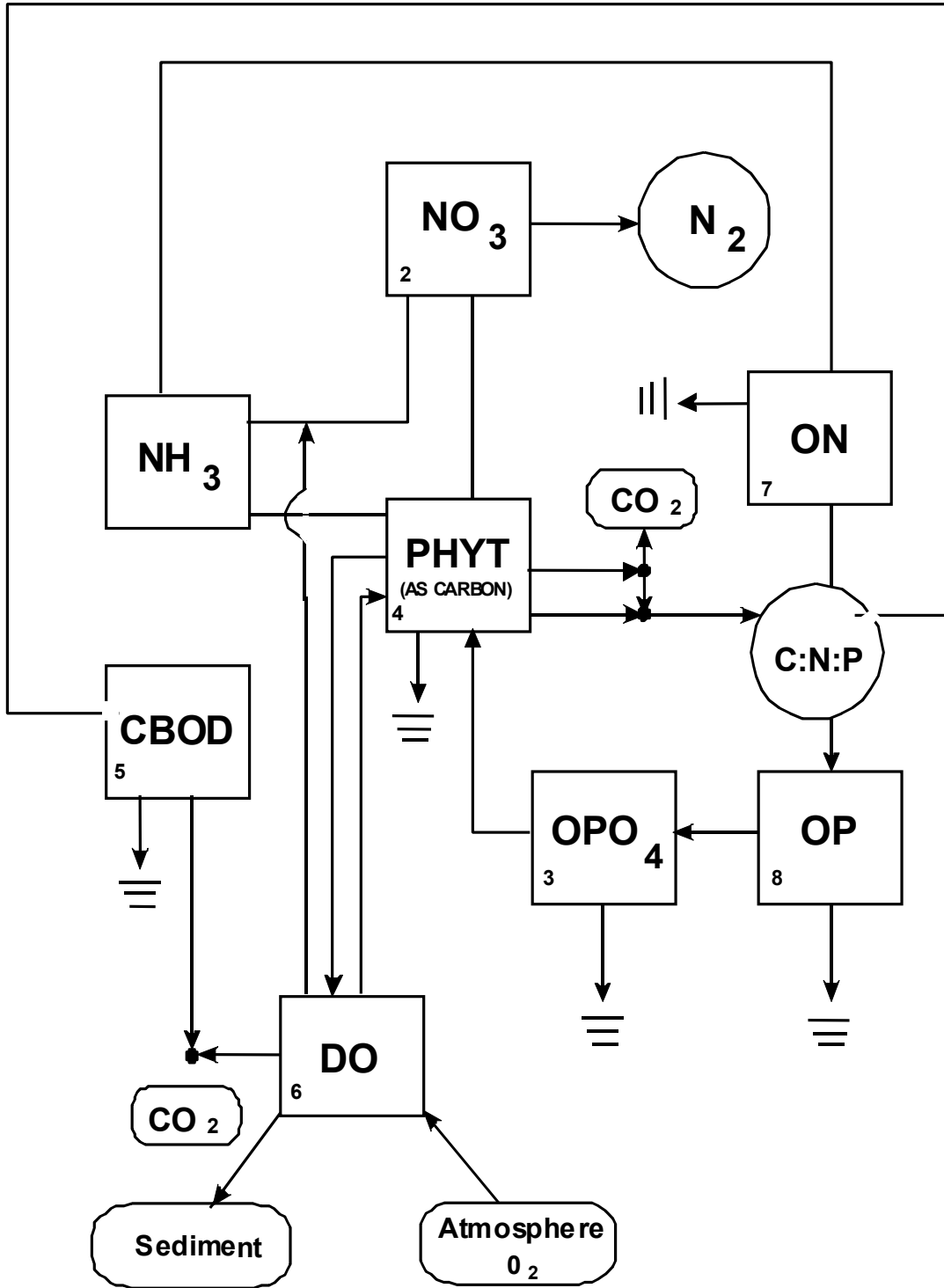

Figure A1: State Variables and Kinetic Interactions in EUTRO5

Table A1: Field and Laboratory Protocols

Parameter	Units	Detection Limits	Method Reference
IN SITU:			
Flow	cfs	0.01 cfs	Meter (Marsh-McBirney Model 2000 Flo-Mate)
Temperature	degrees Celsius	-5 deg. C to 50 deg. C	Linear thermistor network; Hydrolab Multiparameter Water Quality Monitoring Instruments Operating Manual (1995) Surveyor 3 or 4 (HMWQMIOM)
Dissolved Oxygen	mg/L	0 to 20 mg/l	Au/Ag polarographic cell (Clark); HMWQMIOM
Conductivity	micro Siemens/cm ($\mu\text{S/cm}$)	0 to 100,000 $\mu\text{S/cm}$	Temperature-compensated, five electrode cell Surveyor 4; or six electrode Surveyor 3 (HMWQMIOM)
pH	pH units	0 to 14 units	Glass electrode and Ag/AgCl reference electrode pair; HMWQMIOM
Secchi Depth	meters	0.1 m	20.3 cm disk
GRAB SAMPLES:			
Ammonium	mg N / L	0.003	Chesapeake Biological Laboratory. Standard Operating Procedures. TR No. 158-97
Nitrate + Nitrite	mg N / L	0.0007	Chesapeake Biological Laboratory. Standard Operating Procedures. TR No. 158-97
Nitrite	mg N / L	0.0003	Chesapeake Biological Laboratory. Standard Operating Procedures. TR No. 158-97
Total Dissolved Nitrogen	mg N / L	0.03	Chesapeake Biological Laboratory. Standard Operating Procedures. TR No. 158-97
Particulate Nitrogen	mg N / L	0.0123	Chesapeake Biological Laboratory. Standard Operating Procedures. TR No. 158-97
Ortho-phosphate	mg P / L	0.0007	Chesapeake Biological Laboratory. Standard Operating Procedures. TR No. 158-97
Total Dissolved Phosphorus	mg P / L	0.0015	Chesapeake Biological Laboratory. Standard Operating Procedures. TR No. 158-97
Total Phosphorus	mg P / L		Chesapeake Biological Laboratory. Standard Operating Procedures. TR No. 158-97
Particulate Phosphorus	mg P / L	0.0024	Chesapeake Biological Laboratory. Standard Operating Procedures. TR No. 158-97
Dissolved Organic Carbon	mg C / L	0.15	Chesapeake Biological Laboratory. Standard Operating Procedures. TR No. 158-97
Particulate Carbon	mg C / L	0.0759	Chesapeake Biological Laboratory. Standard Operating Procedures. TR No. 158-97
Silicate	mg Si / L	0.01	Chesapeake Biological Laboratory. Standard Operating Procedures. TR No. 158-97
Total Suspended Solids	mg / L	2.4	Chesapeake Biological Laboratory. Standard Operating Procedures. TR No. 158-97
Chlorophyll <i>a</i>	$\mu\text{g/L}$	1 mg/cu.M	Standard methods for the Examination of Water and Wastewater (15 th ed.) #1002G. Chlorophyll. Pp 950-954
BOD ₅	mg/l	0.01 mg/l	Oxidation ** EPA No. 405

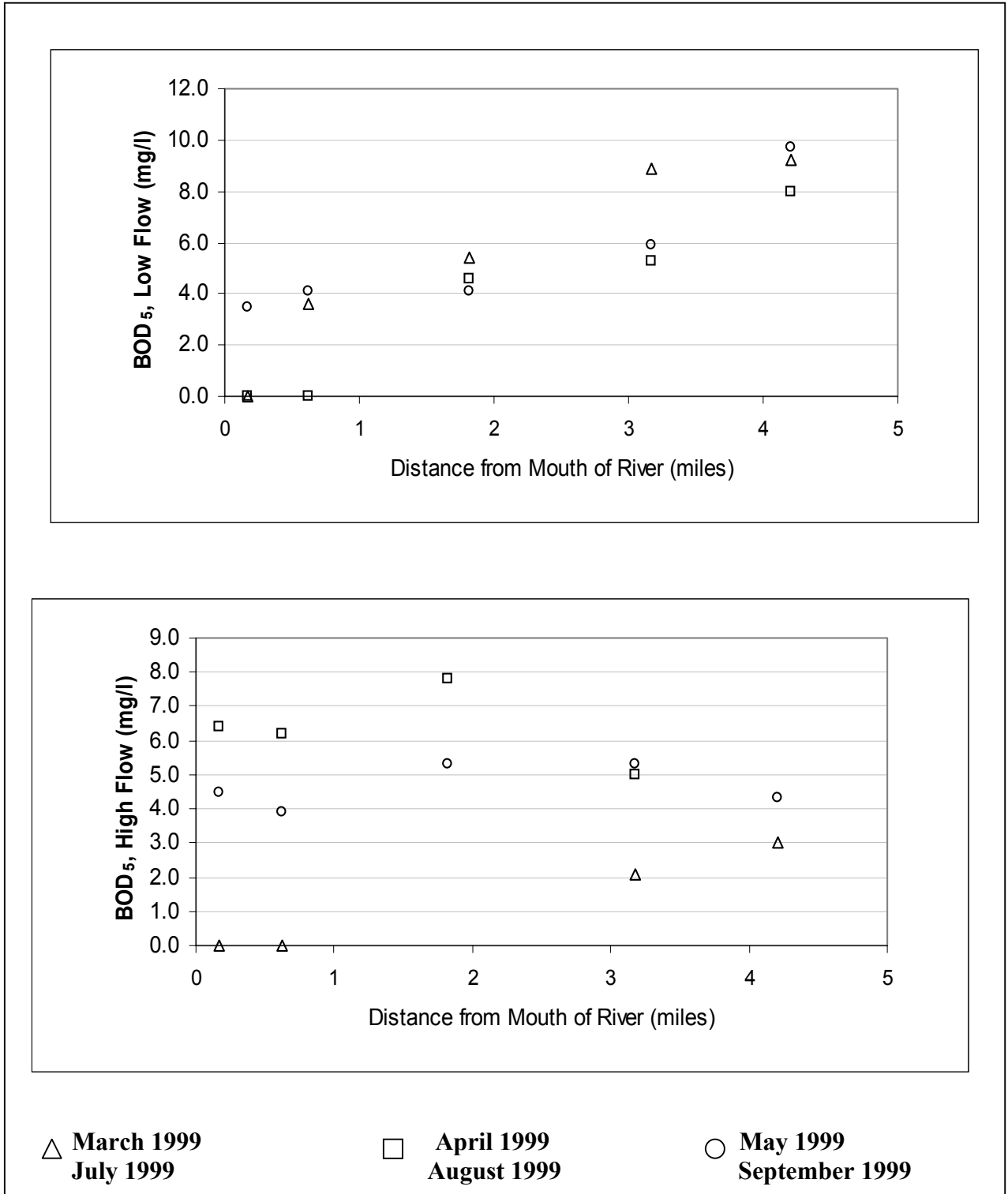

Figure A2: Longitudinal Profile of Biochemical Oxygen Demand Data

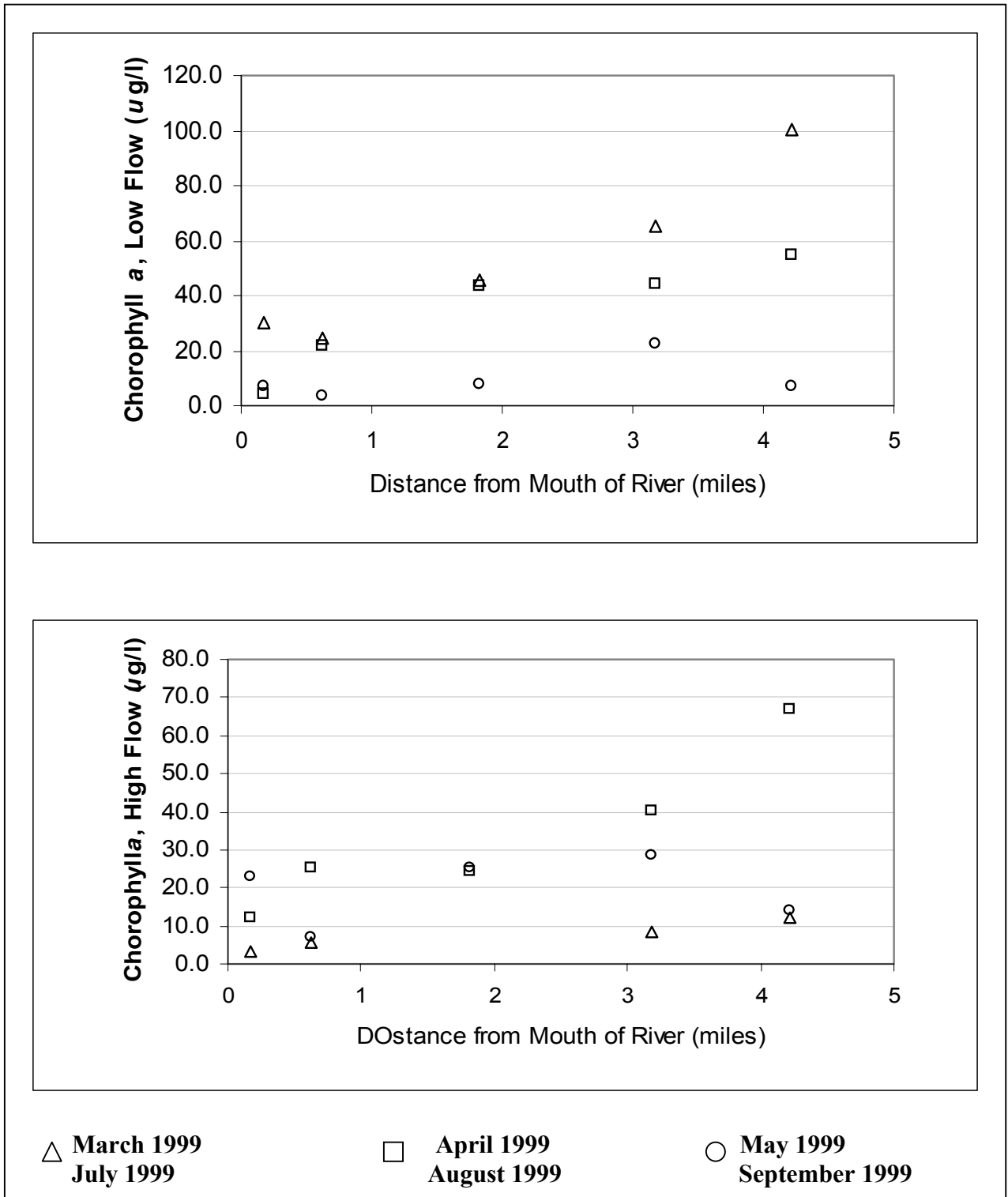

Figure A3: Longitudinal profile of Chlorophyll *a* data

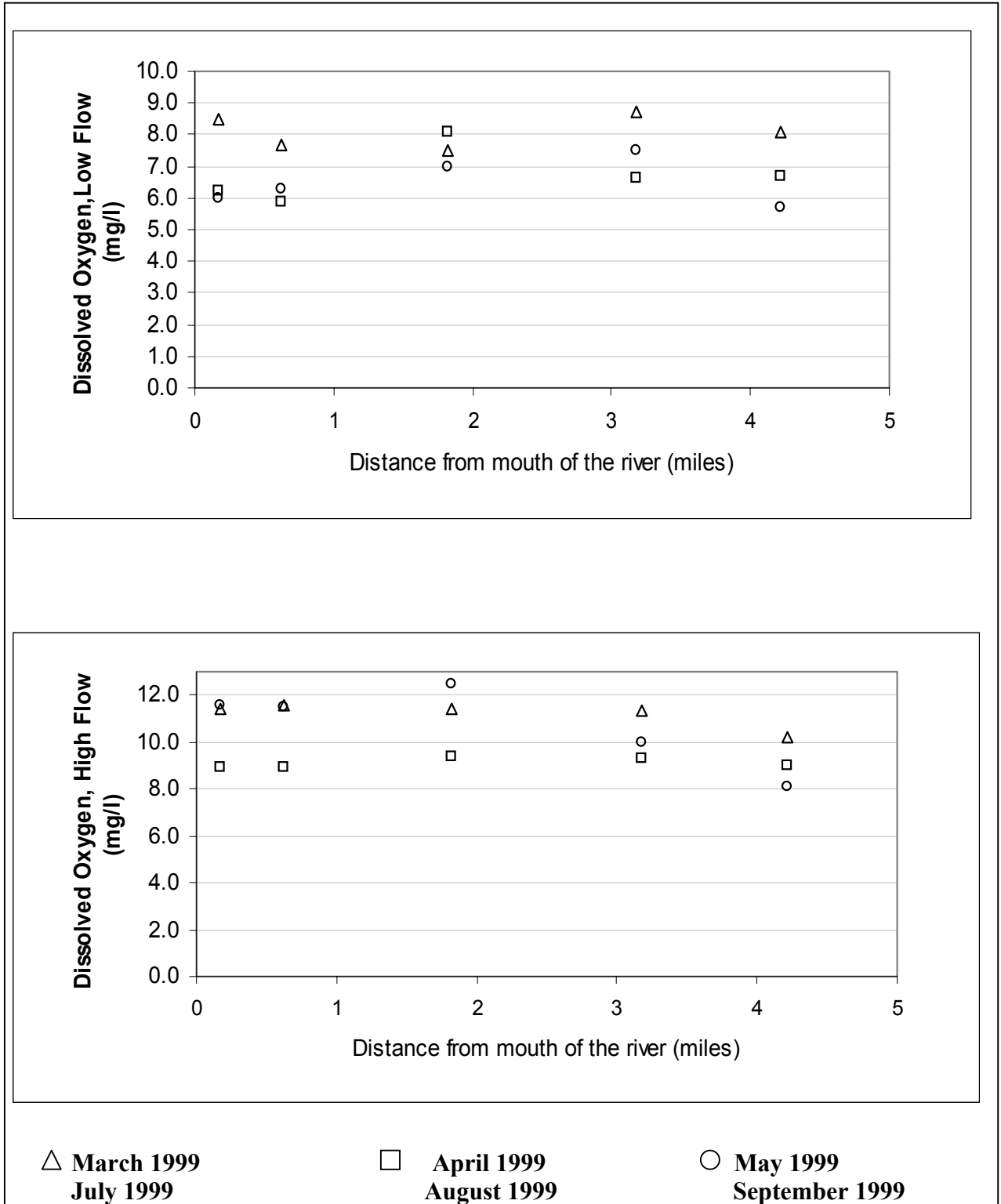

Figure A4: Longitudinal Profile of Dissolved Oxygen Data

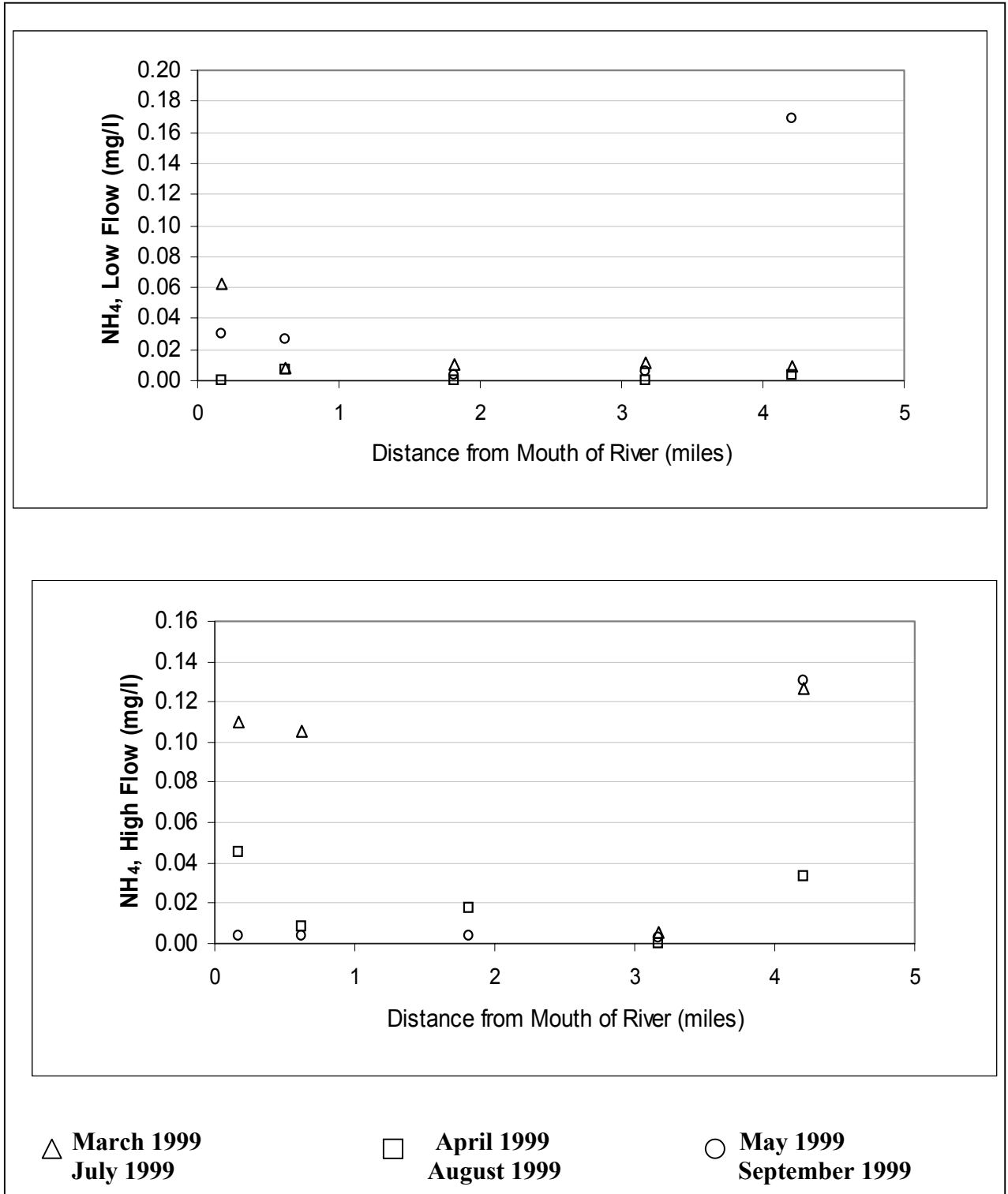

Figure A5: Longitudinal Profile of Ammonia Data

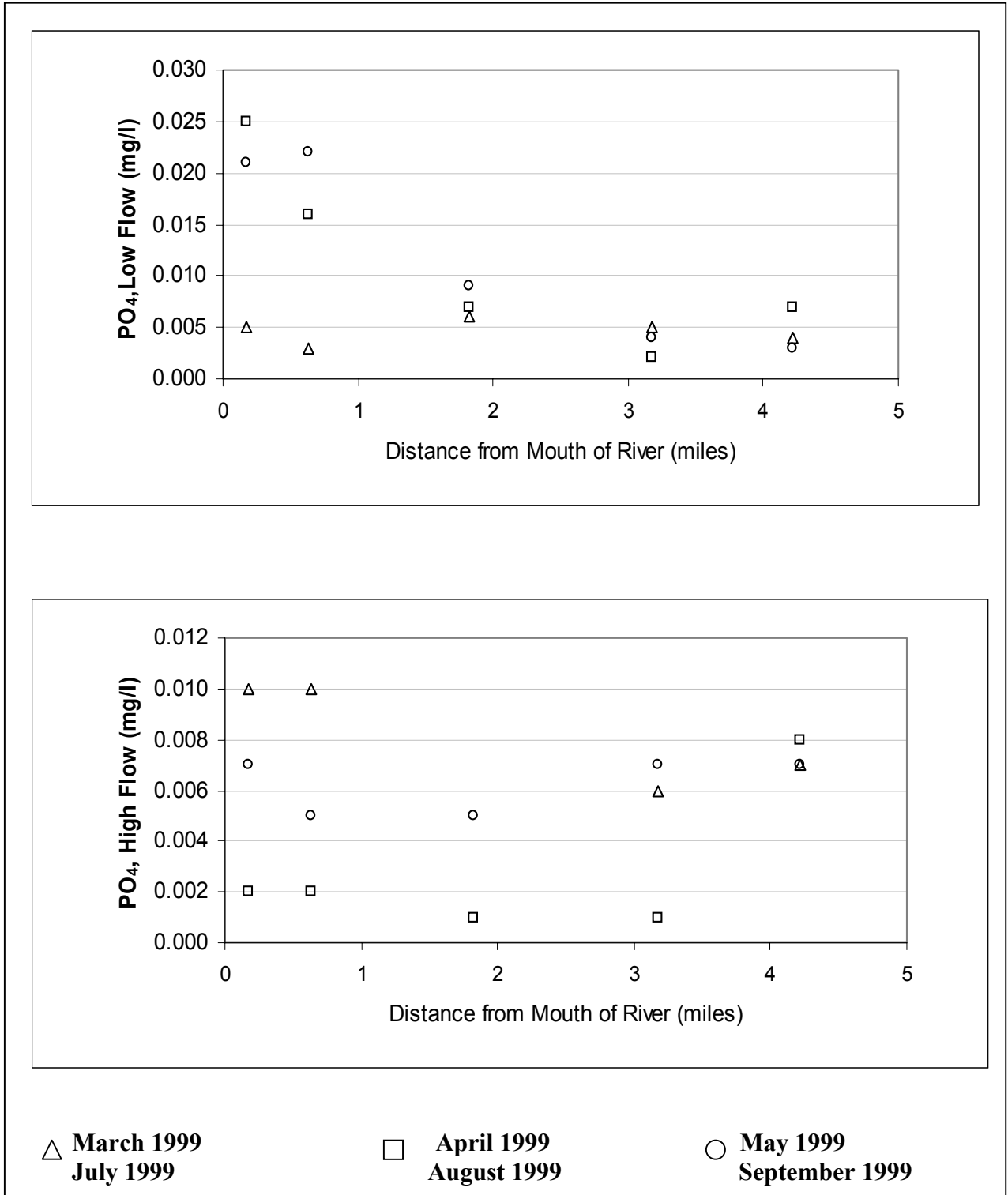

Figure A6: Longitudinal Profile of Inorganic Phosphorus Data

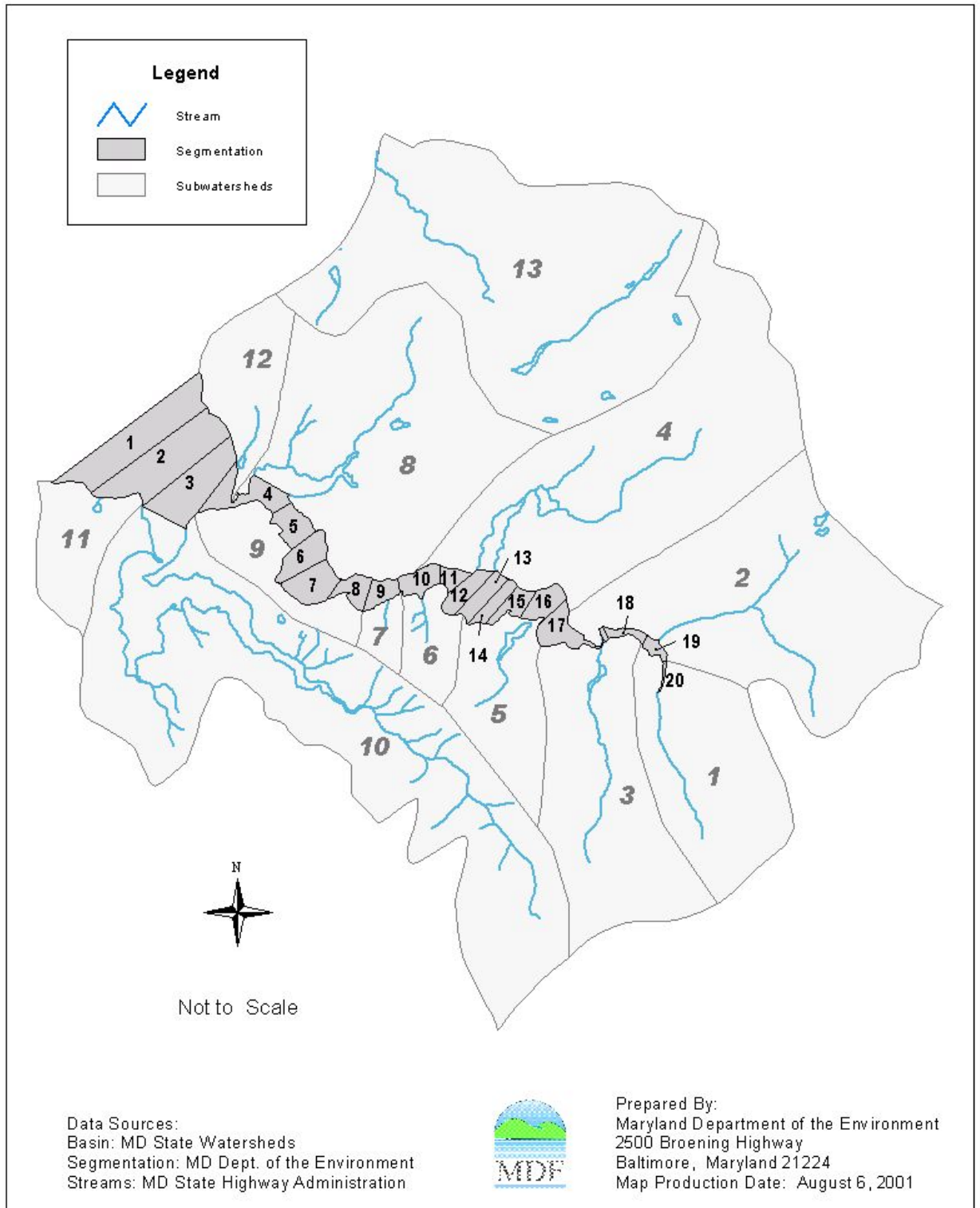

Figure A7: Model Segmentation, including Subwatersheds

Table A2: Volumes, Characteristic Lengths, Interfacial Areas used in the SPCEM

Segment No.	Volume (m ³)	Segment Pair	Characteristic Length (m)	Interfacial Area (m ²)
1	2480668	0-1	373	7757
2	2371905	1-2	426	5544
3	1368897	2-3	430	4380
4	803784	3-4	671	2806
5	419356	4-5	717	682
6	362646	5-6	414	1091
7	342862	6-7	400	952
8	270839	7-8	442	593
9	182015	8-9	417	638
10	147163	9-10	439	288
11	155037	10-11	393	319
12	170548	11-12	251	715
13	151829	12-13	186	974
14	134809	13-14	173	823
15	158350	14-15	224	709
16	129269	15-16	296	455
17	124123	16-17	600	355
18	36330	17-18	685	90
19	14434	18-19	438	59
20	2635	19-20	348	16

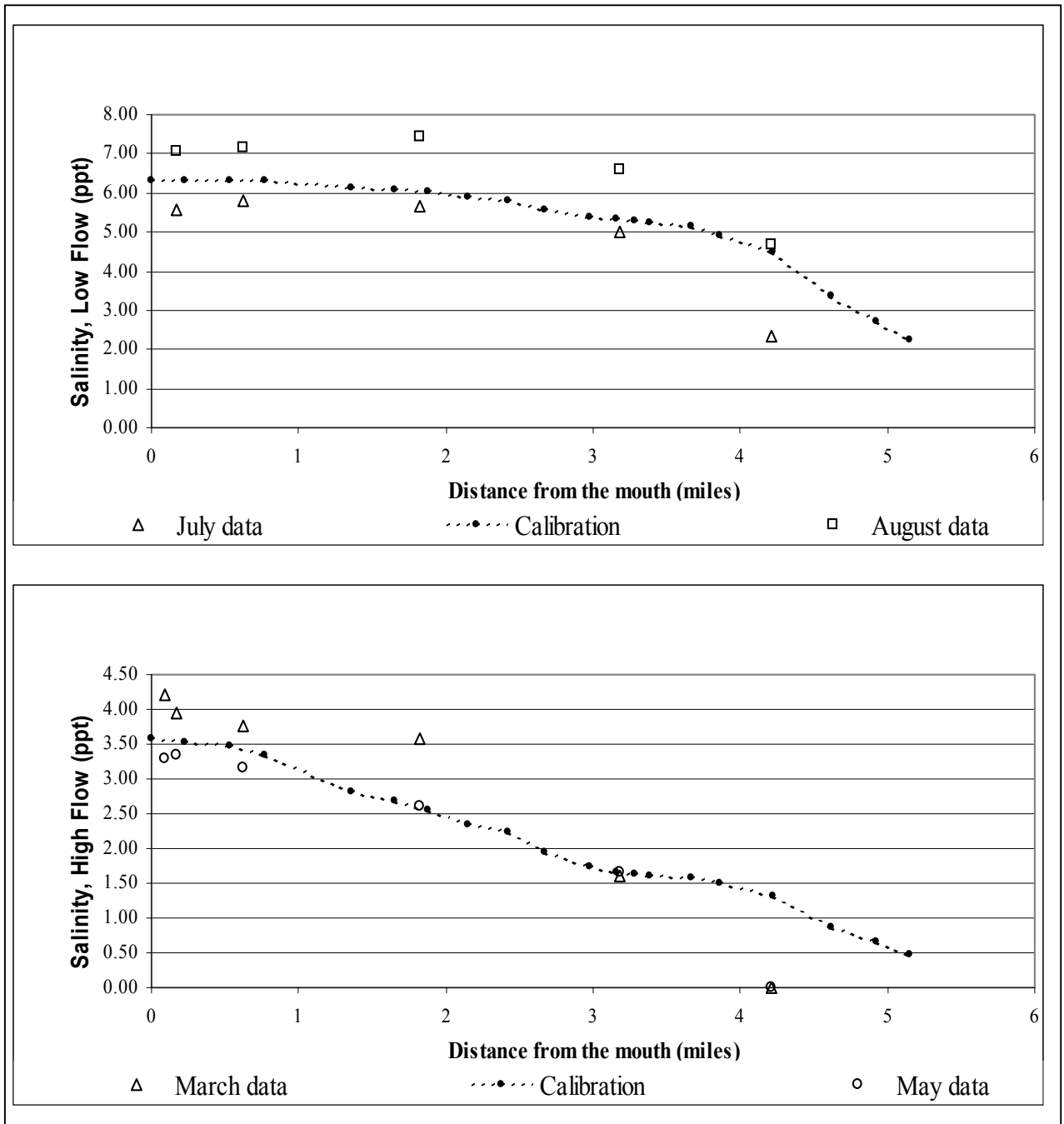

Figure A8: Results of the Calibration of Dispersion Coefficients

Table A3: Dispersion Coefficients used in the SPCEM

Segment Pair	Dispersion Coefficient (m ² /sec)
Tidal Water Segments	
0-1	5
1-2	5
2-3	5
3-4	5
4-5	5
5-6	5
6-7	5
7-8	3
8-9	2
9-10	4
10-11	4
11-12	4
12-13	2
13-14	2
14-15	2
15-16	2
16-17	2
17-18	2
18-19	3
19-20	2

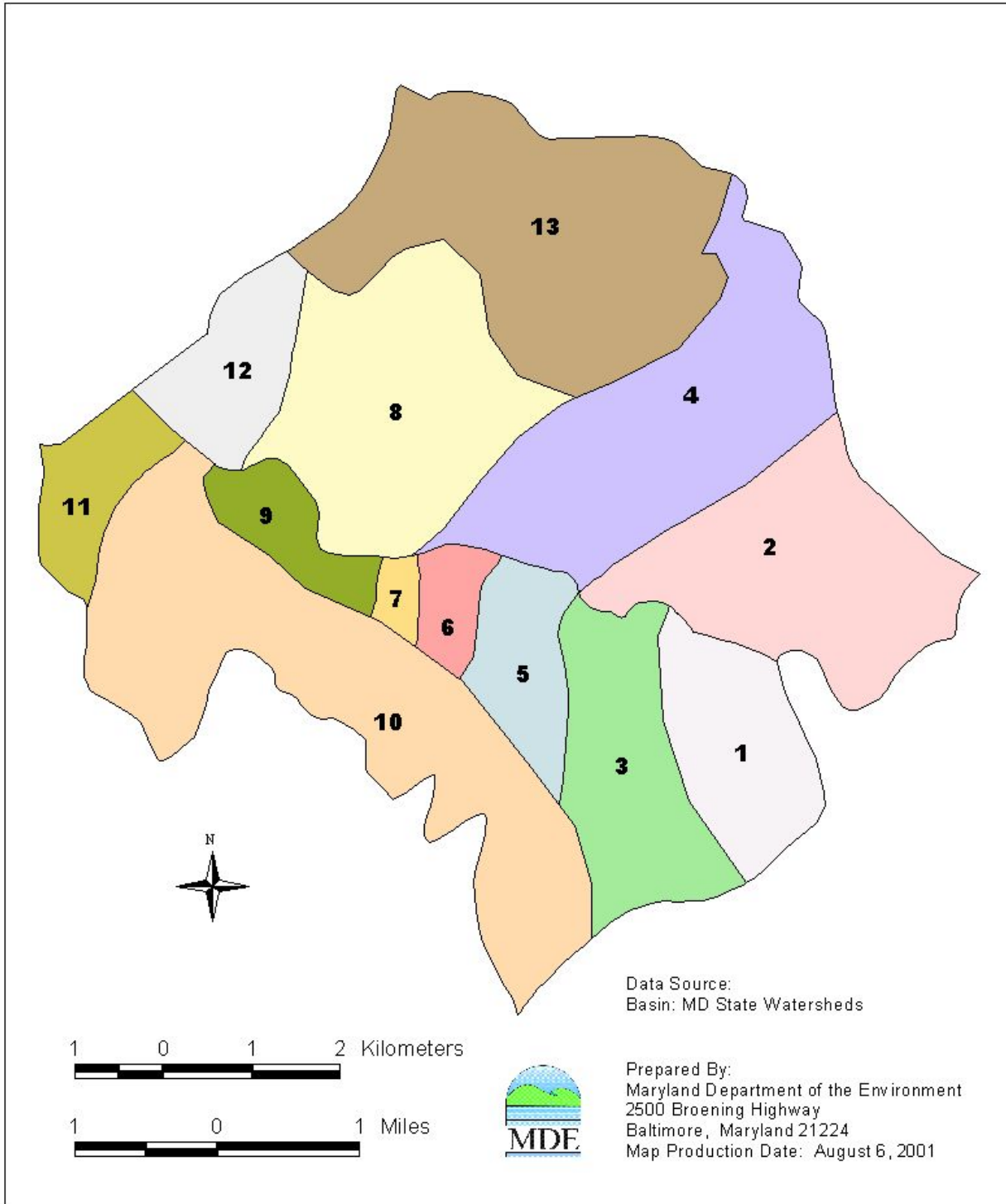

Figure A9: The Eleven Subwatersheds of the Still Pond Creek Drainage Basin

Table A4: Subwatersheds Flows for Low Flow, High Flow, Low Flow Baseline and Average Flow Conditions

subwatershed Number	low flow	high flow	low flow baseline	average flow
1	0.0202	0.0340	0.0065	0.0300
2	0.0395	0.0665	0.0127	0.0586
3	0.0257	0.0433	0.0083	0.0382
4	0.0476	0.0802	0.0153	0.0706
5	0.0125	0.0211	0.0040	0.0186
6	0.0055	0.0092	0.0018	0.0081
7	0.0024	0.0040	0.0008	0.0036
8	0.0423	0.0713	0.0136	0.0628
9	0.0000	0.0151	0.0000	0.0133
10	0.0645	0.1086	0.0207	0.0957
11	0.0110	0.0184	0.0035	0.0162
12	0.0145	0.0244	0.0047	0.0215
13	This subwatershed does not discharge to the model segments			

* All flows in m³/s

Table A5: Solar Radiation and Photoperiod used in the Calibration of the Model.

Parameter	Unit	High Flow (March, May)	Low Flow (July, August)
Solar Radiation	<i>Langleys</i>	300	450
Photoperiod	<i>Fraction of a day</i>	0.55	0.55

Table A6: Environmental Parameters for the Calibration of the Model

Segment Number	Ke (m ⁻¹)		T (°C)		Salinity (mg/L)		SOD (g O ₂ /m ² day)		FNH ₄ (mg NH ₄ -N/m ² day)		FPO ₄ (mg PO ₄ -P/m ² day)	
	High flow	Low flow	High flow	Low flow	High flow	Low flow	High flow	Low flow	High flow	Low flow	High flow	Low flow
1	4.0	1.9	11.5	26.7	3.6	6.6	0.5	1.0	0.0	120	0.0	12.0
2	4.0	1.9	11.5	26.7	3.5	6.7	0.5	1.0	0.0	120	0.0	12.0
3	4.0	1.9	11.5	26.7	3.4	6.7	0.5	1.0	0.0	120	0.0	12.0
4	6.0	3.2	11.5	26.7	3.3	6.7	0.5	1.0	0.0	120	0.0	12.0
5	10.0	4.5	11.5	26.7	329	6.7	0.5	1.0	0.0	120	0.0	12.0
6	12.0	4.5	13.0	27.1	3.1	6.7	0.5	1.0	0.0	120	0.0	12.0
7	12.0	5.8	13.0	27.1	2.8	6.7	0.5	1.0	0.0	120	0.0	12.0
8	10.0	5.8	14.5	27.1	2.6	6.6	0.5	1.0	0.0	120	0.0	12.0
9	10.0	7.1	14.5	27.1	2.4	6.6	0.5	1.0	0.0	120	0.0	12.0
10	10.0	7.1	14.5	27.1	2.1	6.6	0.5	1.0	0.0	120	0.0	12.0
11	8.0	7.1	14.5	27.5	1.9	6.5	0.5	1.0	0.0	120	0.0	12.0
12	8.0	7.1	14.5	27.5	1.6	6.5	0.5	1.0	0.0	120	0.0	12.0
13	6.0	7.1	14.5	27.5	1.4	6.4	0.5	1.0	0.0	120	00	12.0
14	6.0	7.1	14.5	27.5	1.1	5.9	0.5	1.0	0.0	120	00	12.0
15	6.0	7.1	14.5	27.1	0.7	5.4	0.5	1.0	0.0	120	00	12.0
16	4.0	5.8	14.5	27.1	0.3	4.9	0.5	1.0	0.0	120	0.0	12.0
17	4.0	5.8	14.5	27.1	0.0	4.4	0.5	1.0	0.0	120	0.0	12.0
18	6.0	4.5	14.5	27.1	0.0	3.6	0.5	1.0	0.0	120	0.0	12.0
19	8.0	4.5	14.5	27.1	0.0	3.4	0.5	1.0	0.0	120	0.0	12.0
20	10.0	5.8	14.5	27.1	0.0	1.9	0.5	1.0	0.0	120	0.0	12.0

Table A7: EUTRO5 Kinetic Coefficients

Constant	Code	Value
Nitrification rate	K12C	0.12 <i>day</i> ⁻¹ at 20° C
temperature coefficient	K12T	1.08
Denitrification rate	K20C	0.08 <i>day</i> ⁻¹ at 20° C
temperature coefficient	K20T	1.08
Saturated growth rate of phytoplankton	K1C	1.5 <i>day</i> ⁻¹ at 20° C
temperature coefficient	K1T	1.08
Endogenous respiration rate	K1RC	0.06 <i>day</i> ⁻¹ at 20° C
temperature coefficient	K1RT	1.045
Nonpredatory phytoplankton death rate	K1D	0.05 <i>day</i> ⁻¹
Phytoplankton Stoichiometry		
Oxygen-to-carbon ratio	OCRB	2.67 <i>mg O₂/mg C</i>
Carbon-to-chlorophyll ratio	CCHL	35
Nitrogen-to-carbon ratio	NCRB	0.25 <i>mg N/mg C</i>
Phosphorus-to-carbon ratio	PCRB	0.025 <i>mg PO₄-P/mg C</i>
Half-saturation constants for phytoplankton growth		
Nitrogen	KMNG1	0.010 <i>mg N / L</i>
Phosphorus	KMPG1	0.001 <i>mg P / P</i>
Fraction of dead phytoplankton recycled to organic		
nitrogen	FON	0.6
phosphorus	FOP	0.5
Light Formulation Switch	LGHTS	1 = Smith
Saturation light intensity for phytoplankton	IS1	300. <i>Ly/day</i>
BOD deoxygenation rate	KDC	0.10 <i>day</i> ⁻¹ at 20° C
temperature coefficient	KDT	1.05
Reaeration rate constant	k2	0.30 <i>day</i> ⁻¹ at 20° C
Mineralization rate of dissolved organic nitrogen	K71C	0.010 <i>day</i> ⁻¹
temperature coefficient	K71T	1.08
Mineralization rate of dissolved organic phosphorus	K58C	0.10 <i>day</i> ⁻¹
temperature coefficient	K58T	1.08
Phytoplankton settling velocity		0.173 <i>m/day</i>
Inorganics settling velocity		0.173 <i>m/day</i>

Table A8: Contributing Watersheds to Each Model Segment, and Flows for the Segments

Segment	Contributing Subwatershed	Low Flow	High Flow	Low Flow Baseline	Average
2	11	0.0110	0.0184	0.0035	0.0162
3	10	0.0645	0.1086	0.0207	0.0957
4	8+12	0.0454	0.0764	0.0146	0.0673
5	9	0.0000	0.0076	0.0000	0.0067
7	8	0.0000	0.0071	0.0000	0.0063
8	9	0.0000	0.0076	0.0000	0.0067
9	7	0.0024	0.0040	0.0008	0.0036
10	6	0.0055	0.0092	0.0018	0.0081
12	4	0.0476	0.0802	0.0153	0.0706
16	5	0.0125	0.0211	0.0040	0.0186
17	3	0.0257	0.0433	0.0083	0.0382
19	2	0.0395	0.0665	0.0127	0.0586
20	1	0.0202	0.0340	0.0065	0.0300

Segment Number	NH4 <i>mg/l</i>	NO₂₃ <i>mg/l</i>	PO₄ <i>mg/l</i>	CHL <i>a</i> <i>µg/l</i>	CBOD <i>mg/l</i>	DO <i>mg/l</i>	ON <i>mg/l</i>	OP <i>mg/l</i>
1	0.063	0.352	0.015	17.32	1.00	7.35	0.251	0.0112
2	0.081	0.480	0.040	3.99	3.67	6.40	0.441	0.0667
3	0.010	0.216	0.006	35.26	6.50	8.85	0.647	0.0135
4	0.081	0.480	0.040	3.99	3.67	6.40	0.441	0.0667
9	0.081	0.480	0.040	3.99	3.67	6.40	0.441	0.0667
10	0.081	0.480	0.040	3.99	3.67	6.40	0.441	0.0667
12	0.081	0.480	0.040	3.99	3.67	6.40	0.441	0.0667
16	0.081	0.480	0.040	3.99	3.67	6.40	0.441	0.0667
17	0.081	0.480	0.040	3.99	3.67	6.40	0.441	0.0667
19	0.081	0.480	0.040	3.99	3.67	6.40	0.441	0.0667
20	0.081	0.480	0.040	3.99	3.67	6.40	0.441	0.0667

Table A9: Nonpoint Source Concentrations for the Low Flow Calibration of the Model

Segment Number	NH4 <i>mg/l</i>	NO₂₃ <i>mg/l</i>	PO₄ <i>mg/l</i>	CHL <i>a</i> <i>µg/l</i>	CBOD <i>mg/l</i>	DO <i>mg/l</i>	ON <i>mg/l</i>	OP <i>mg/l</i>
1	0.057	0.734	0.0090	13.2	3.75	11.5	0.465	0.0070
2	0.147	1.405	0.0215	23.9	6.42	9.70	1.377	0.0172
3	0.095	0.671	0.0070	10.8	2.92	9.15	0.515	0.0070
4	0.147	1.405	0.0215	23.9	6.42	9.70	1.377	0.0172
5	0.147	1.405	0.0215	23.9	6.42	9.70	1.377	0.0172
7	0.147	1.405	0.0215	23.9	6.42	9.70	1.377	0.0172
8	0.147	1.405	0.0215	23.9	6.42	9.70	1.377	0.0172
9	0.147	1.405	0.0215	23.9	6.42	9.70	1.377	0.0172
10	0.147	1.405	0.0215	23.9	6.42	9.70	1.377	0.0172
12	0.147	1.405	0.0215	23.9	6.42	9.70	1.377	0.0172
16	0.147	1.405	0.0215	23.9	6.42	9.70	1.377	0.0172
17	0.147	1.405	0.0215	23.9	6.42	9.70	1.377	0.0172
19	0.147	1.405	0.0215	23.9	6.42	9.70	1.377	0.0172
20	0.147	1.405	0.0215	23.9	6.42	9.70	1.377	0.0172

Table A10: Nonpoint Source Concentrations for the High Flow Calibration of the Model

Low Flow Calibration

Figure A10: BOD₅ vs. River Mile for the Calibration of the Model (Low flow)

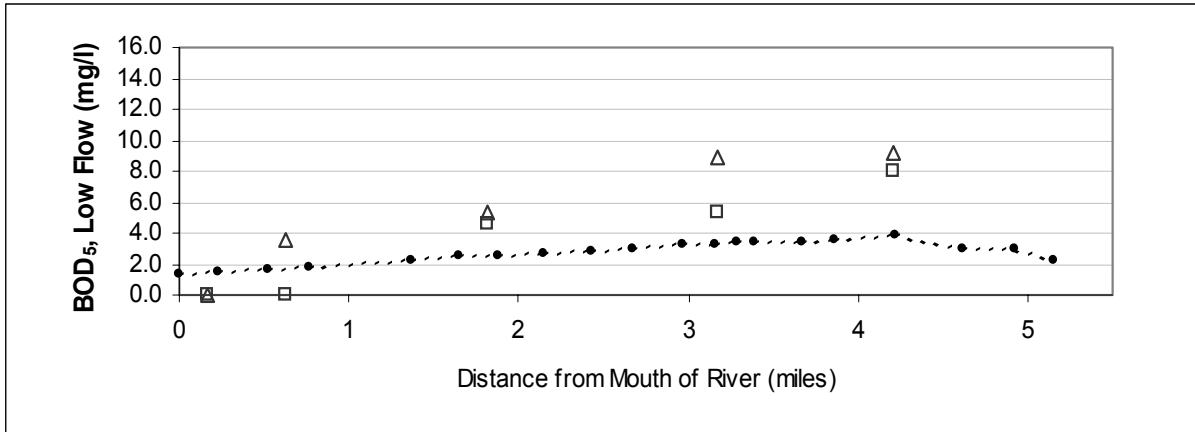

Figure A11: Dissolved Oxygen vs. River Mile for the Calibration of the Model (Low flow)

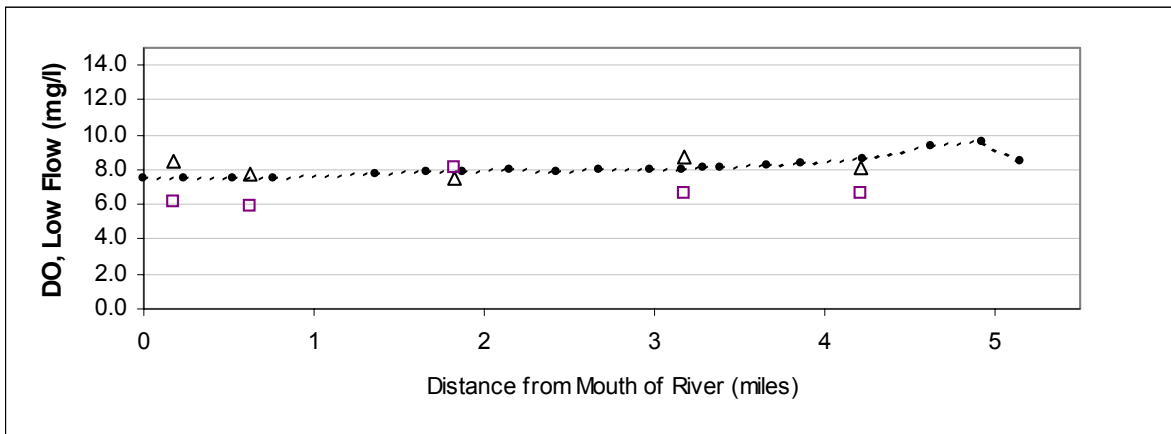
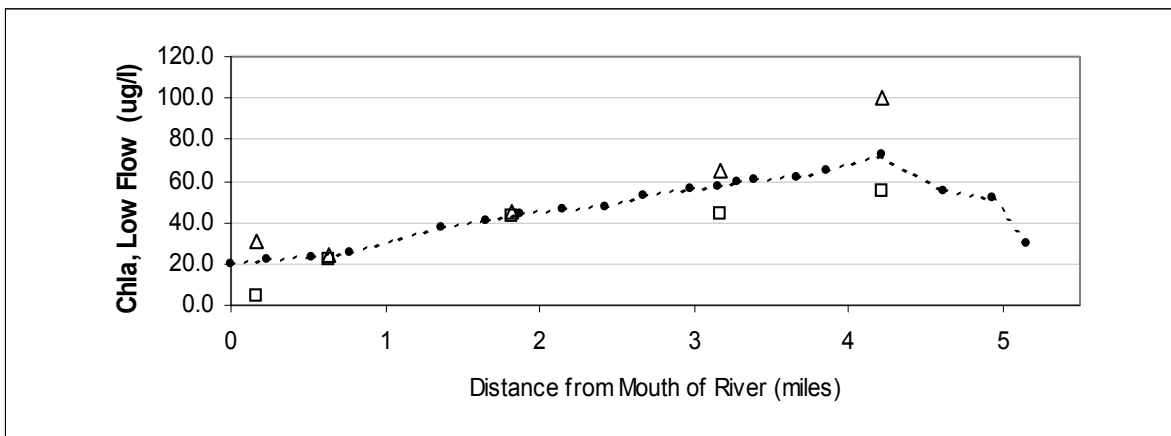

Figure A12: Chlorophyll *a* vs. River Mile for the Calibration of the Model (Low flow)



△ July
□ August
----- Calibration

Figure A13: Nitrate (plus Nitrite) vs. River Mile for the Calibration of the Model (Low flow)

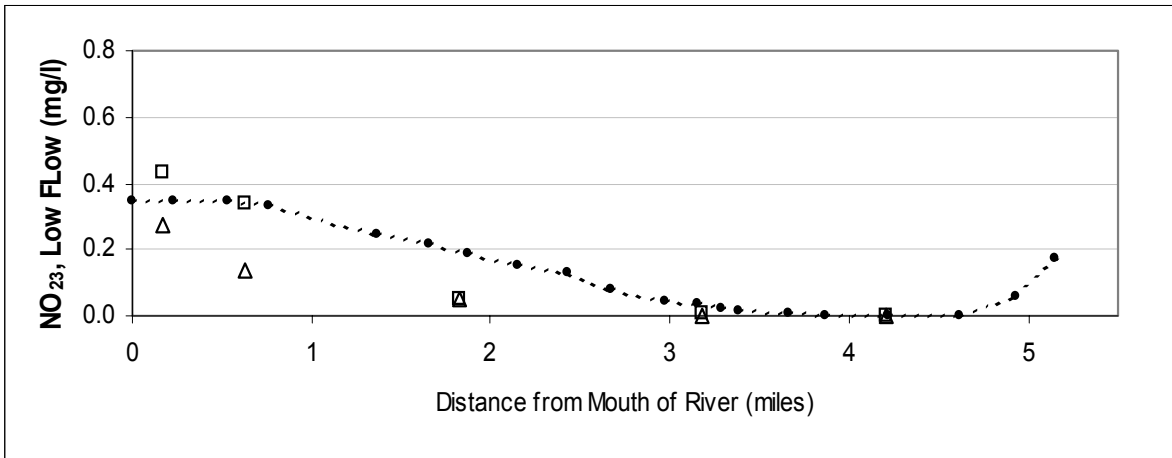

Figure A14: Organic Nitrogen vs. River Mile for the Calibration of the Model (Low flow)

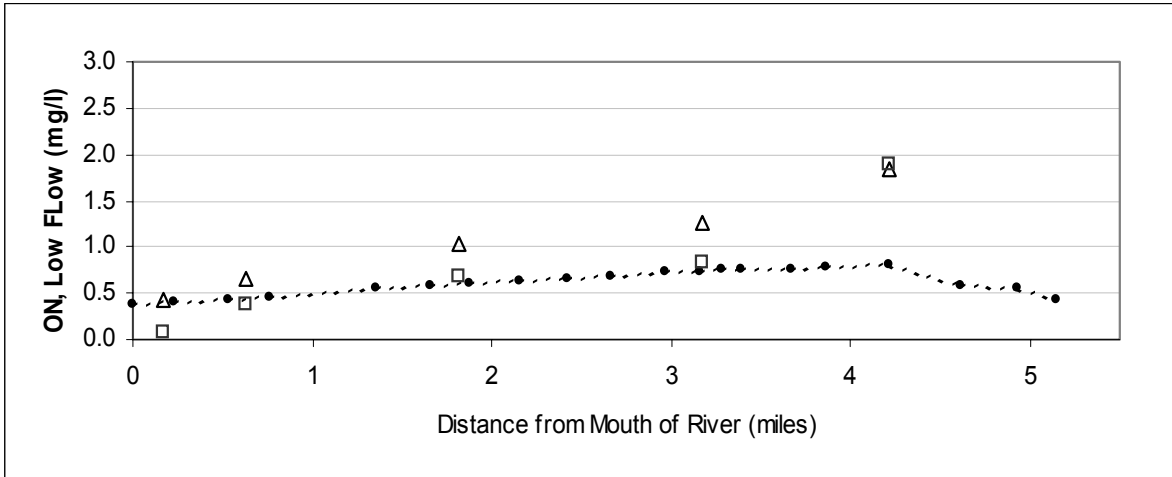
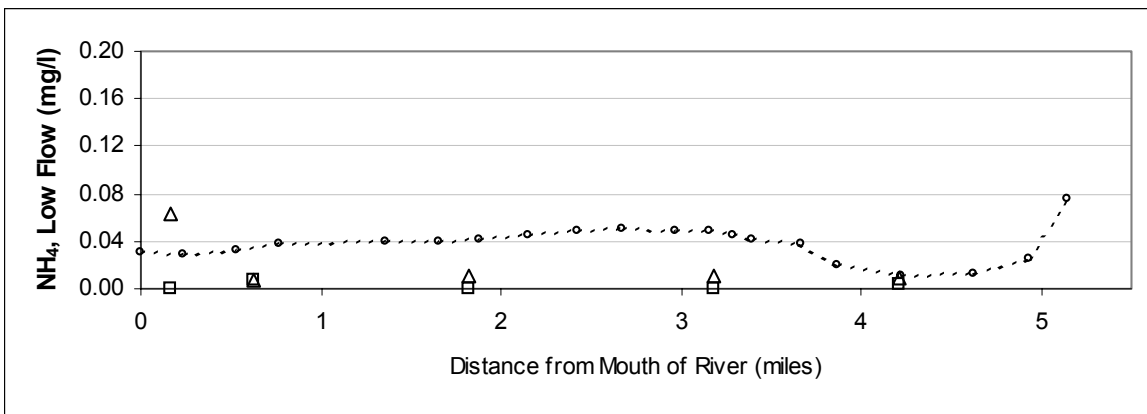

Figure A15: Ammonia vs. River Mile for the Calibration of the Model (Low flow)



△ July □ August ----- Calibration

Figure A16: Organic Phosphorus vs. River Mile for the Calibration of the Model (Low flow)

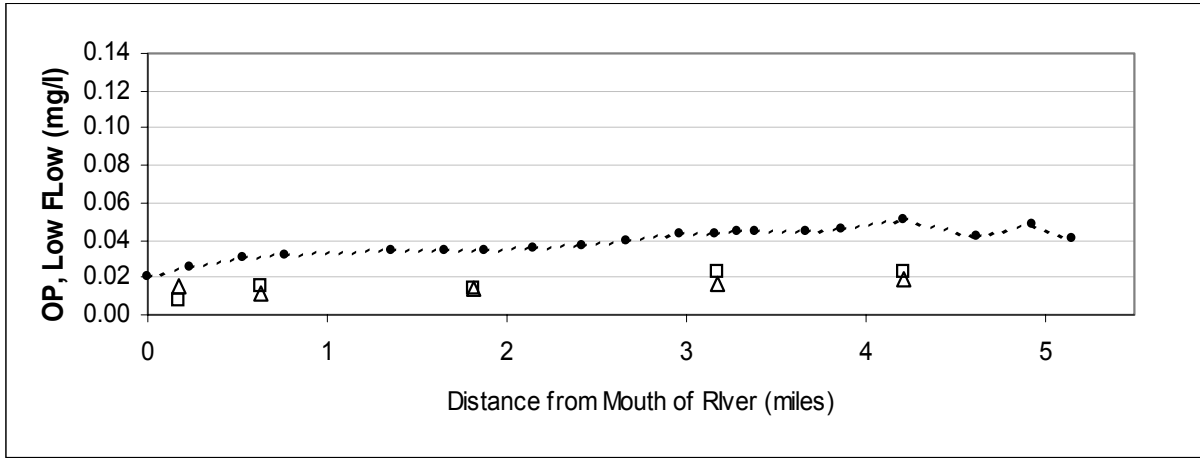
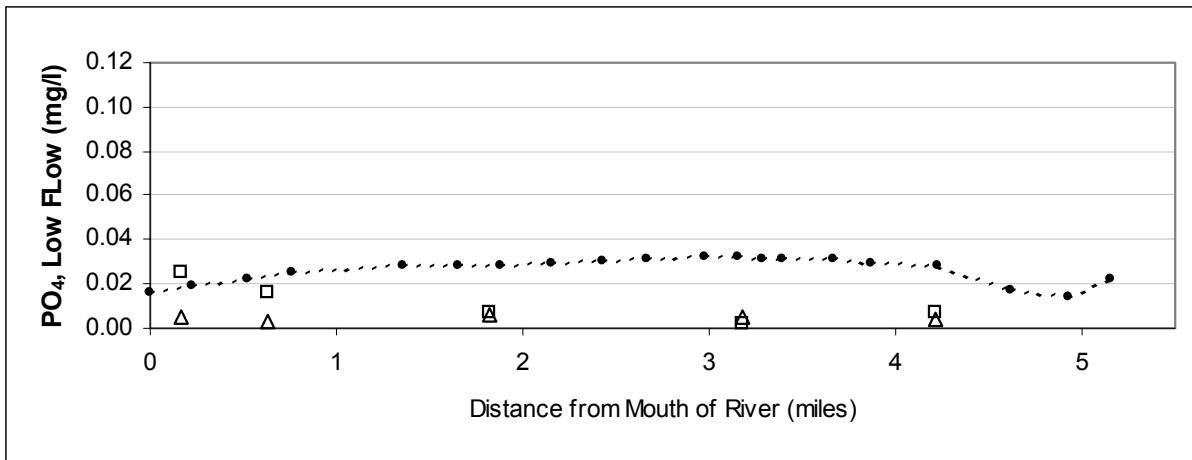

Figure A17: Ortho-Phosphate vs. River Mile for the Calibration of the Model (Low flow)



△ July

□ August

----- Calibration

High Flow Calibration

Figure A18: BOD vs. River Mile for the Calibration of the Model (High flow)

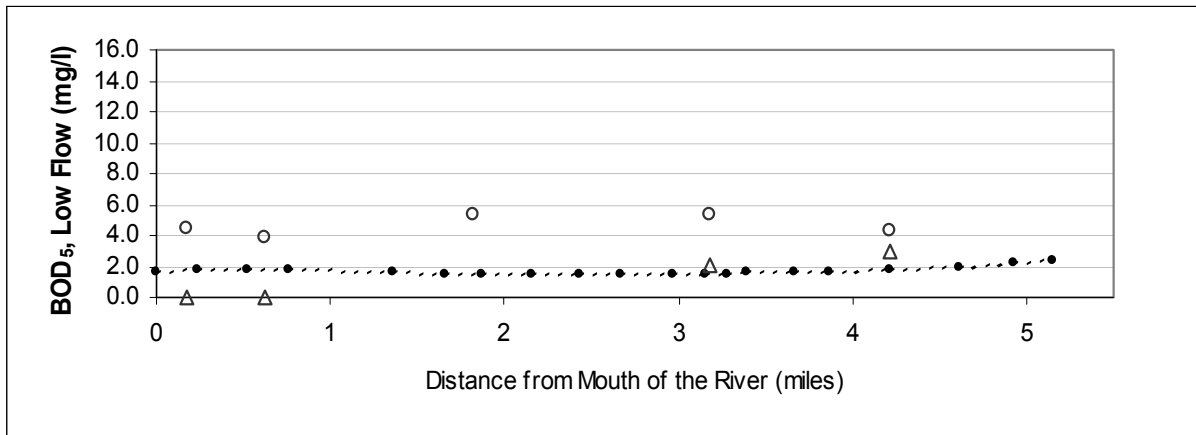

Figure A19: Dissolved Oxygen vs. River Mile for the Calibration of the Model (High Flow)

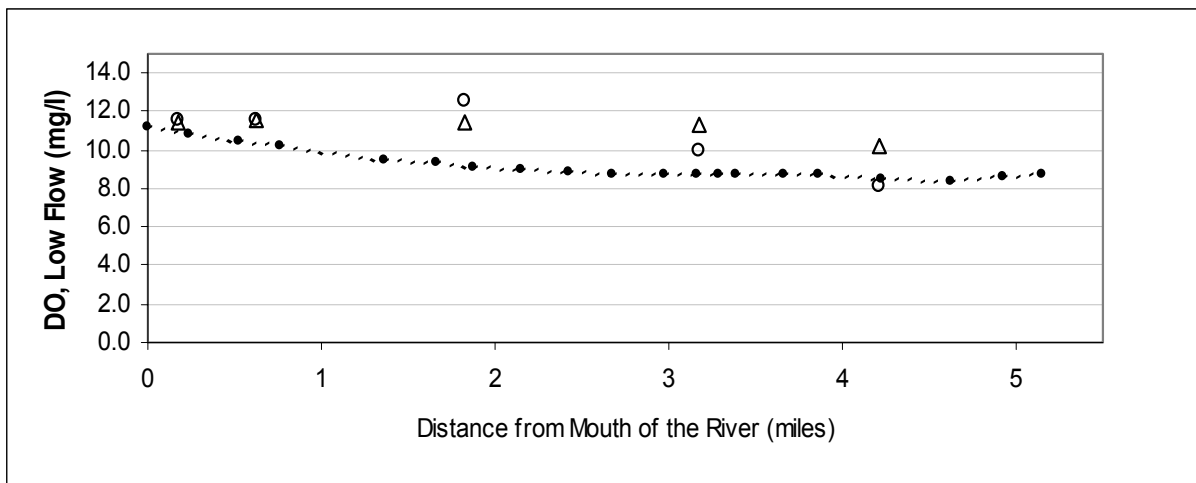
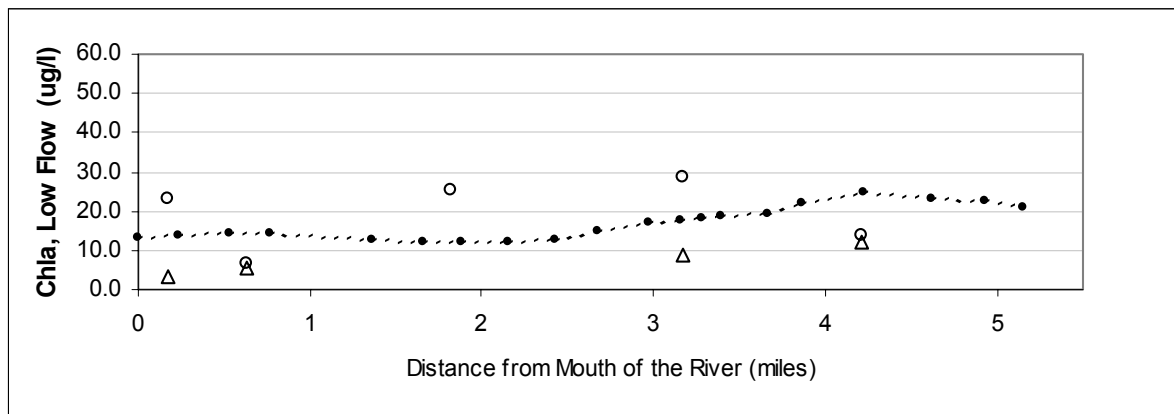

Figure A20: Chlorophyll a vs. River Mile for the Calibration of the Model (High flow)



△ March
○ May
----- Calibration

Figure A21: Nitrate (plus Nitrite) vs. River Mile for the Calibration of the Model (High flow)

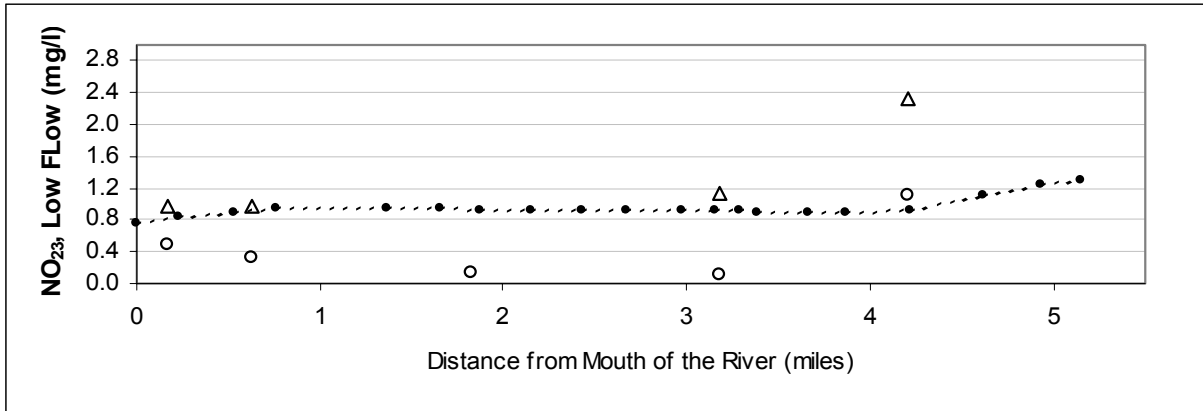

Figure A22: Organic Nitrogen vs. River Mile for the Calibration of the Model (High flow)

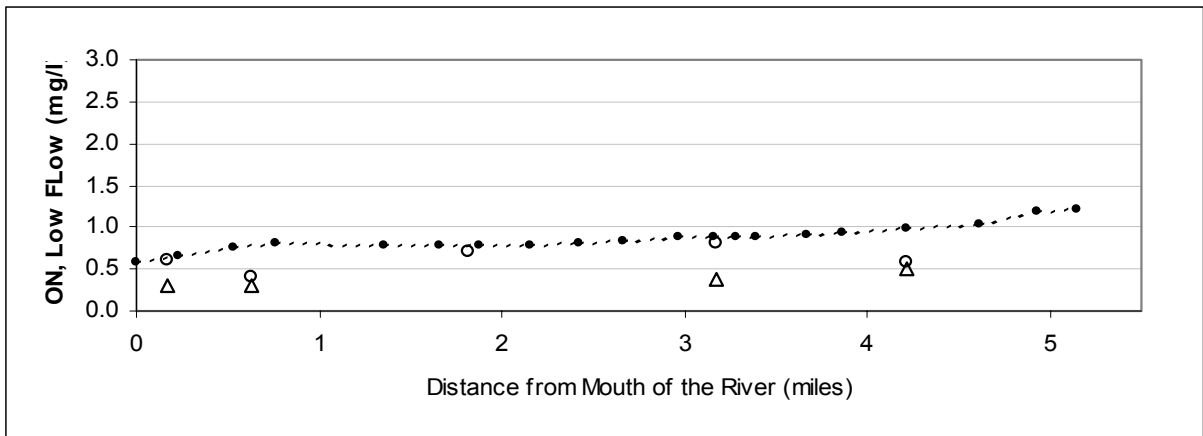
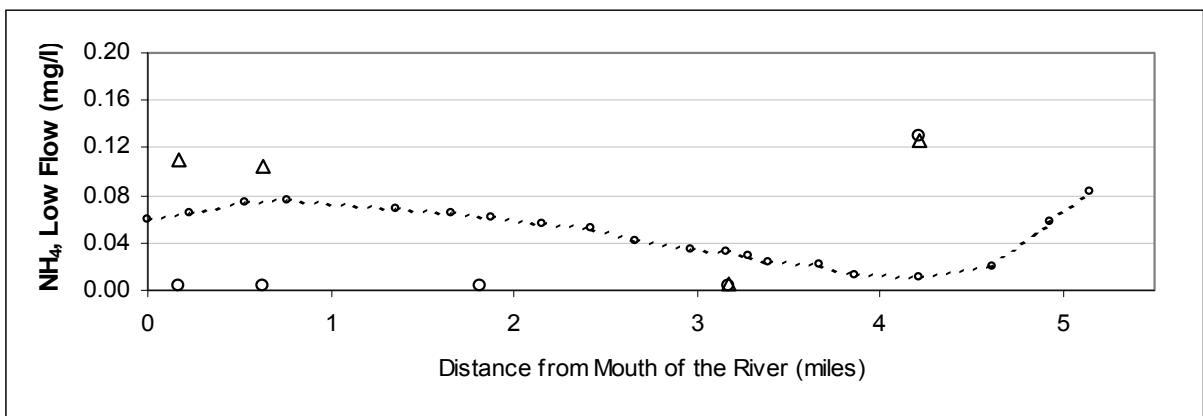

Figure A23: Ammonia vs. River Mile for the Calibration of the Model (High flow)



△ March

○ May

----- Calibration

Figure A24: Organic Phosphorus vs. River Mile for the Calibration of the Model (High flow)

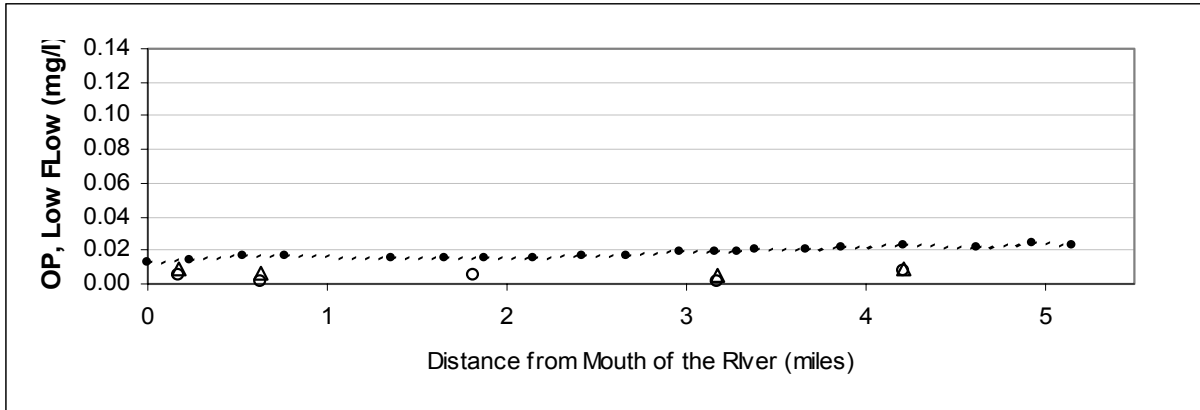
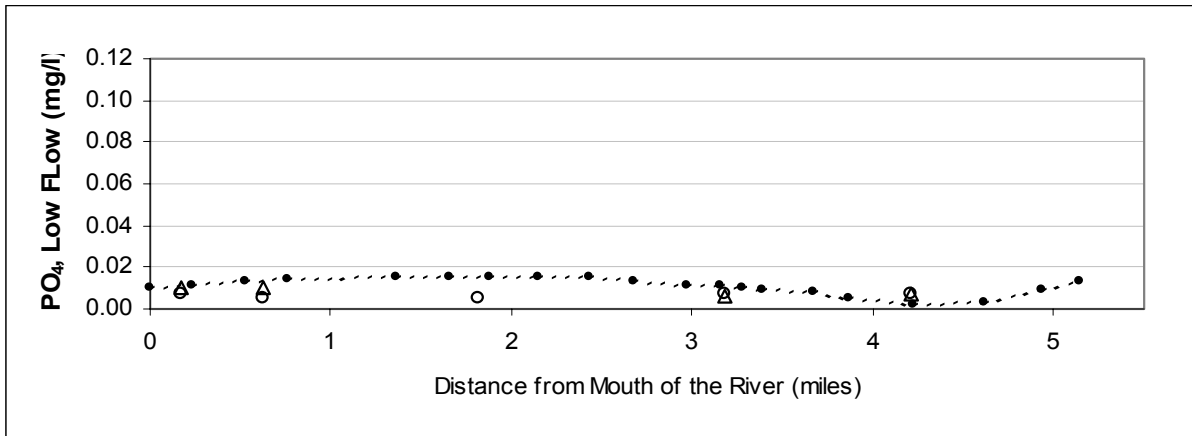

Figure A25: Ortho-Phosphate vs. River Mile for the Calibration of the Model (High flow)



△ March

○ May

----- Calibration

Table A11: Nonpoint Source Concentrations for the Low Flow Baseline Conditions Scenario (Scenario 1)

Segment Number	NH4 <i>mg/l</i>	NO₂₃ <i>mg/l</i>	PO₄ <i>mg/l</i>	CHL <i>a</i> <i>ug/l</i>	CBOD <i>mg/l</i>	DO <i>mg/l</i>	ON <i>mg/l</i>	OP <i>mg/l</i>
1	0.032	0.352	0.015	17.32	1.00	7.35	0.251	0.0112
2	0.081	0.480	0.040	3.99	3.67	6.40	0.441	0.0667
3	0.010	0.216	0.006	35.26	6.50	8.85	0.647	0.0135
4	0.081	0.480	0.040	3.99	3.67	6.40	0.441	0.0667
9	0.081	0.480	0.040	3.99	3.67	6.40	0.441	0.0667
10	0.081	0.480	0.040	3.99	3.67	6.40	0.441	0.0667
12	0.081	0.480	0.040	3.99	3.67	6.40	0.441	0.0667
16	0.081	0.480	0.040	3.99	3.67	6.40	0.441	0.0667
17	0.081	0.480	0.040	3.99	3.67	6.40	0.441	0.0667
19	0.081	0.480	0.040	3.99	3.67	6.40	0.441	0.0667
20	0.081	0.480	0.040	3.99	3.67	6.40	0.441	0.0667

Table A12: Nonpoint Source Concentrations for the Average Flow Baseline Conditions Scenario (Scenario 2)

Segment Number	NH4 <i>mg/l</i>	NO₂₃ <i>mg/l</i>	PO₄ <i>mg/l</i>	CHL <i>a</i> <i>ug/l</i>	CBOD <i>mg/l</i>	DO <i>mg/l</i>	ON <i>mg/l</i>	OP <i>mg/l</i>
1	0.0500	0.582	0.0117	13.4	5.94	8.77	0.334	0.0102
2	0.174	0.872	0.0322	11.3	6.51	8.30	0.816	0.0495
3	0.0400	0.494	0.0057	18.4	5.50	9.32	0.526	0.0100
4	0.174	0.872	0.0322	11.3	6.51	8.30	0.816	0.0495
5	0.174	0.872	0.0322	11.3	6.51	8.30	0.816	0.0495
7	0.174	0.872	0.0322	11.3	6.51	8.30	0.816	0.0495
8	0.174	0.872	0.0322	11.3	6.51	8.30	0.816	0.0495
9	0.174	0.872	0.0322	11.3	6.51	8.30	0.816	0.0495
10	0.174	0.872	0.0322	11.3	6.51	8.30	0.816	0.0495
12	0.174	0.872	0.0322	11.3	6.51	8.30	0.816	0.0495
16	0.174	0.872	0.0322	11.3	6.51	8.30	0.816	0.0495
17	0.174	0.872	0.0322	11.3	6.51	8.30	0.816	0.0495
19	0.174	0.872	0.0322	11.3	6.51	8.30	0.816	0.0495
20	0.174	0.872	0.0322	11.3	6.51	8.30	0.816	0.0495

Table A13: Nonpoint Source Concentrations for the Low Flow Future Conditions Scenario

Segment Number	NH4 mg/l	NO₂₃ mg/l	PO₄ mg/l	CHL <i>a</i> µg/l	CBOD mg/l	DO mg/l	ON mg/l	OP mg/l
1	0.0320	0.352	0.015	17.3	1.00	7.35	0.251	0.0112
2	0.0680	0.367	0.026	3.99	3.67	6.40	0.331	0.0571
3	0.0070	0.144	0.004	35.26	6.50	8.85	0.431	0.0092
4	0.0570	0.320	0.025	3.99	3.67	6.40	0.322	0.494
9	0.0650	0.335	0.025	3.99	3.67	6.40	0.291	0.0500
10	0.0600	0.328	0.025	3.99	3.67	6.40	0.308	0.0521
12	0.0530	0.303	0.025	3.99	3.67	6.40	0.285	0.0451
16	0.0610	0.321	0.025	3.99	3.67	6.40	0.303	0.0492
17	0.0500	0.295	0.025	3.99	3.67	6.40	0.278	0.0424
19	0.0500	0.293	0.025	3.99	3.67	6.40	0.269	0.0413
20	0.0500	0.295	0.025	3.99	3.67	6.40	0.288	0.0419

(Scenario 3)

Table A14: Nonpoint Source Concentrations for the Average Flow Future Conditions Scenario (Scenario 4)

Segment Number	NH4 mg/l	NO₂₃ mg/l	PO₄ mg/l	CHL <i>a</i> µg/l	CBOD mg/l	DO mg/l	ON mg/l	OP mg/l
1	0.0500	0.582	0.0117	13.4	5.94	8.77	0.334	0.0102
2	0.147	0.666	0.0208	11.3	6.51	8.30	0.612	0.0418
3	0.0280	0.329	0.0035	18.4	5.50	9.32	0.350	0.0068
4	0.121	0.582	0.0202	11.3	6.51	8.30	0.596	0.0361
5	0.133	0.589	0.200	11.3	6.51	8.30	0.546	0.0376
7	0.121	0.582	0.202	11.3	6.51	8.30	0.596	0.0362
8	0.133	0.589	0.200	11.3	6.51	8.30	0.546	0.0376
9	0.139	0.609	0.0198	11.3	6.51	8.30	0.538	0.0366
10	0.128	0.596	0.0204	11.3	6.51	8.30	0.569	0.0381
12	0.114	0.550	0.0199	11.3	6.51	8.30	0.528	0.0330
16	0.130	0.582	0.0198	11.3	6.51	8.30	0.561	0.0360
17	0.108	0.536	0.0199	11.3	6.51	8.30	0.515	0.0310
19	0.107	0.532	0.0198	11.3	6.51	8.30	0.497	0.0302
20	0.107	0.536	0.0198	11.3	6.51	8.30	0.532	0.0306

Low Flow Baseline Conditions Scenario

Figure A26: BOD vs. River Mile for the Baseline Conditions Low Flow Scenario

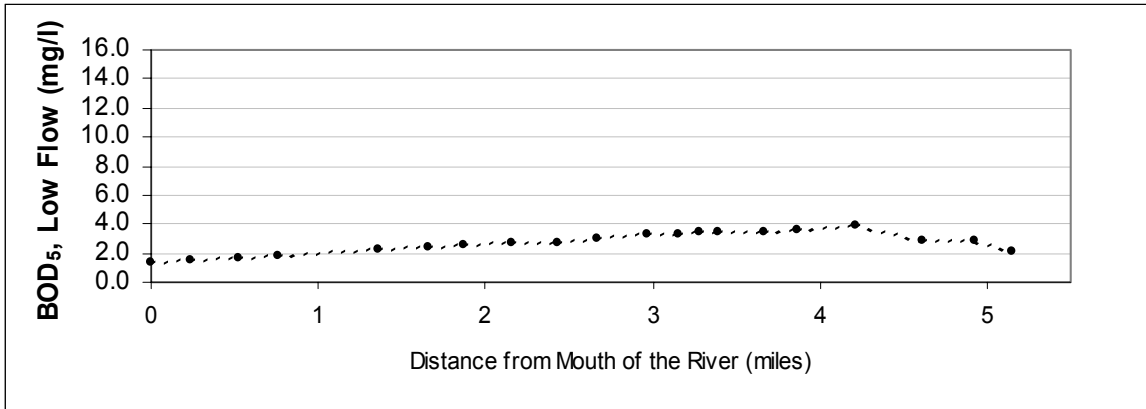

Figure A27: Dissolved Oxygen vs. River Mile for the Baseline Conditions Low Flow Scenario

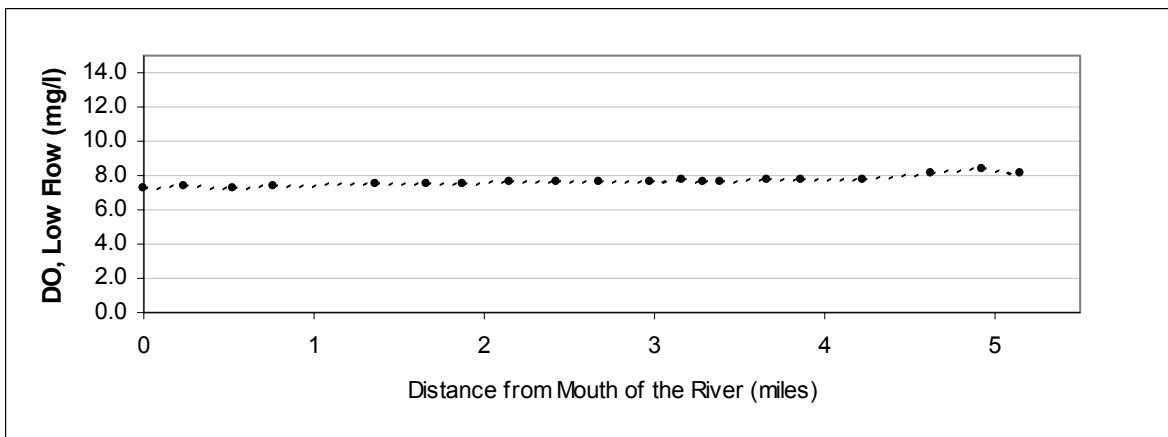
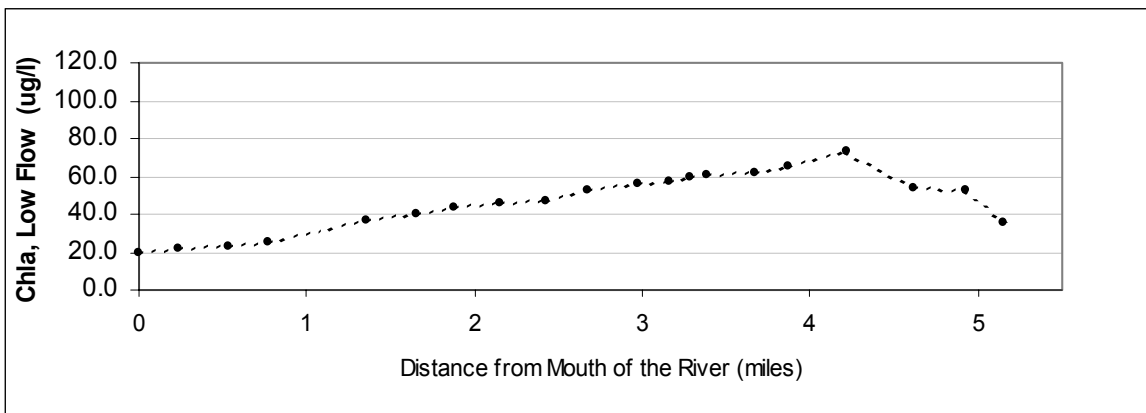

Figure A28: Chlorophyll a vs. River Mile for the Baseline Conditions Low Flow Scenario



..... **Baseline Conditions low flow condition**

Figure A29: Nitrate (plus Nitrite) vs. River Mile for the Baseline Conditions Low Flow Scenario

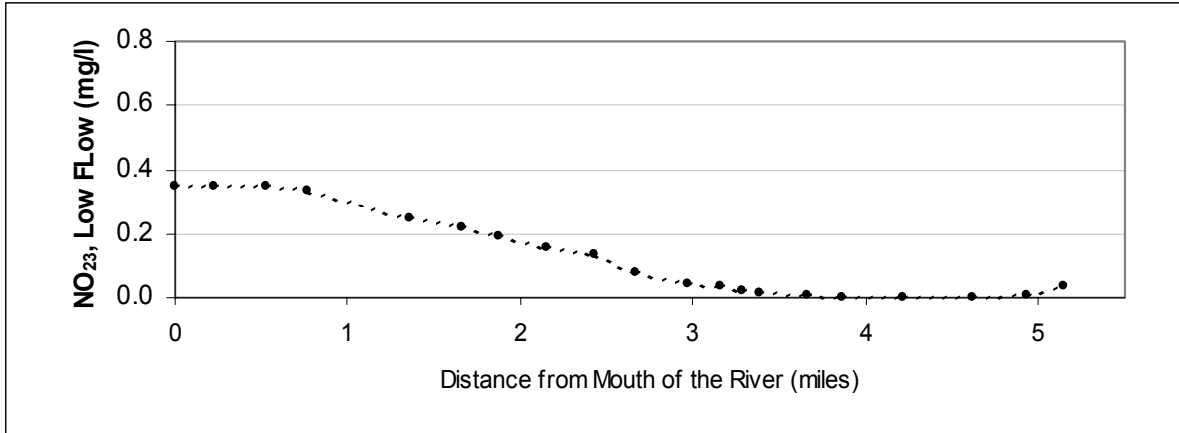

Figure A30: Organic Nitrogen vs. River Mile for the Baseline Conditions Low Flow Scenario

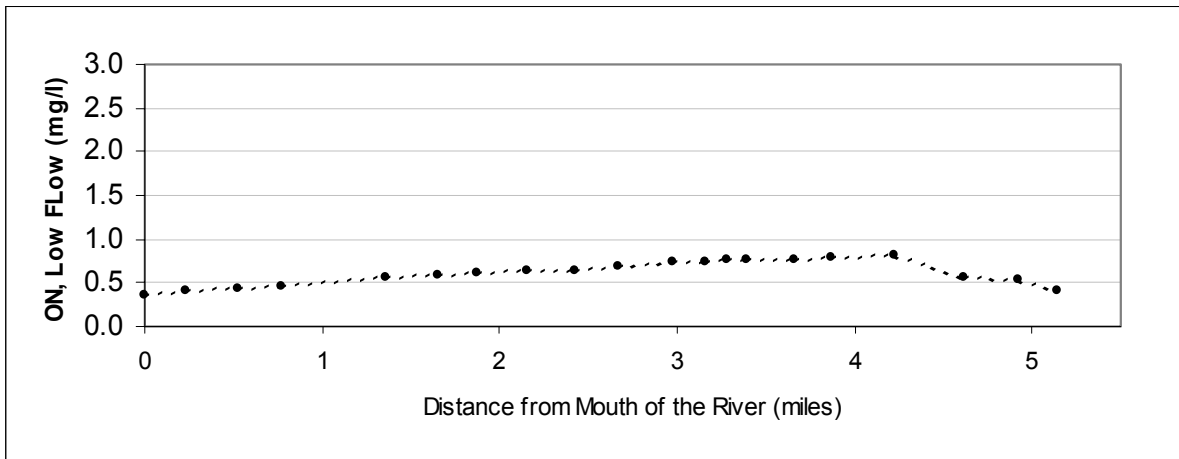
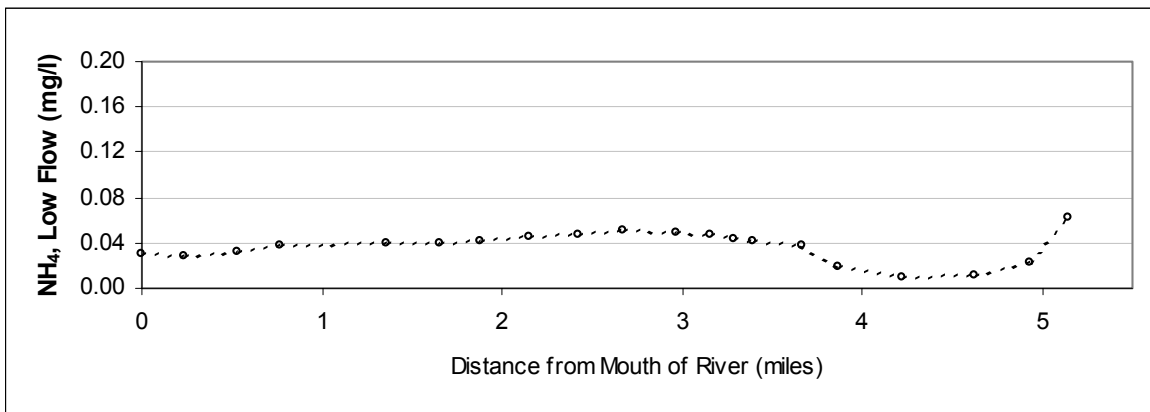

Figure A31: Ammonia vs. River Mile for the Baseline Conditions Low Flow Scenario



..... Low Flow Baseline Conditions

Figure A32: Organic Phosphorus vs. River Mile for the Baseline Conditions Low Flow Scenario

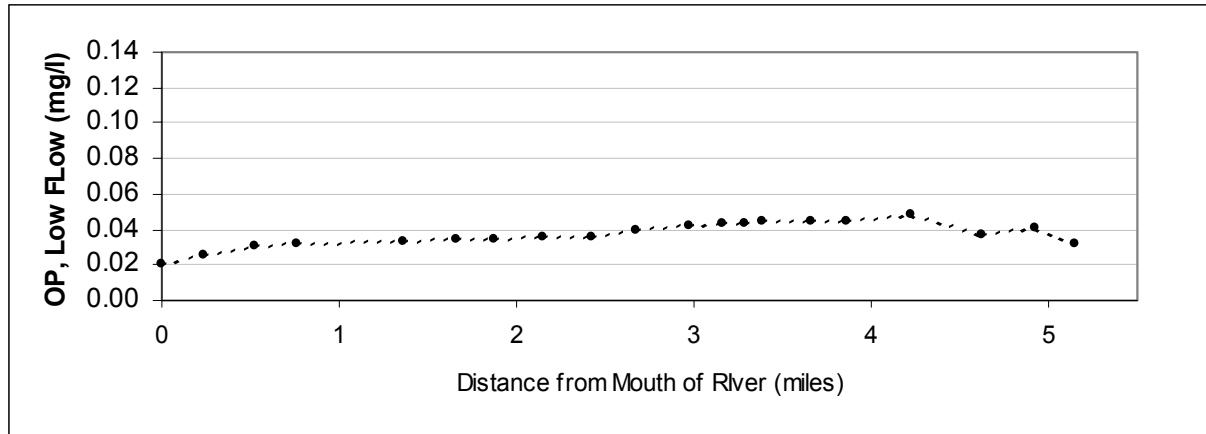
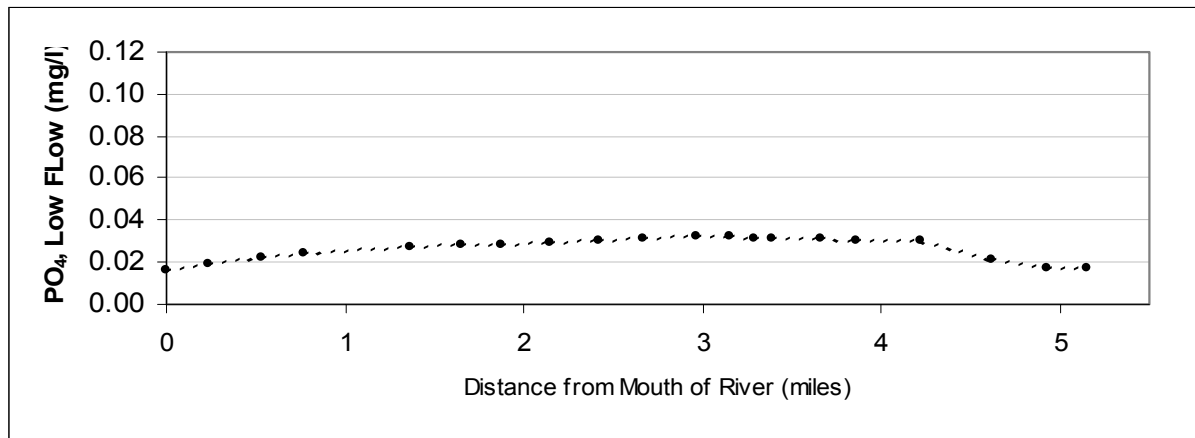

Figure A33: Ortho-Phosphorus vs. River Mile for the Baseline Conditions Low Flow Scenario



..... Low Flow Baseline Conditions

Baseline Conditions Average Flow Scenario

Figure A34: BOD vs. River Mile for the Baseline Conditions Average Flow Scenario

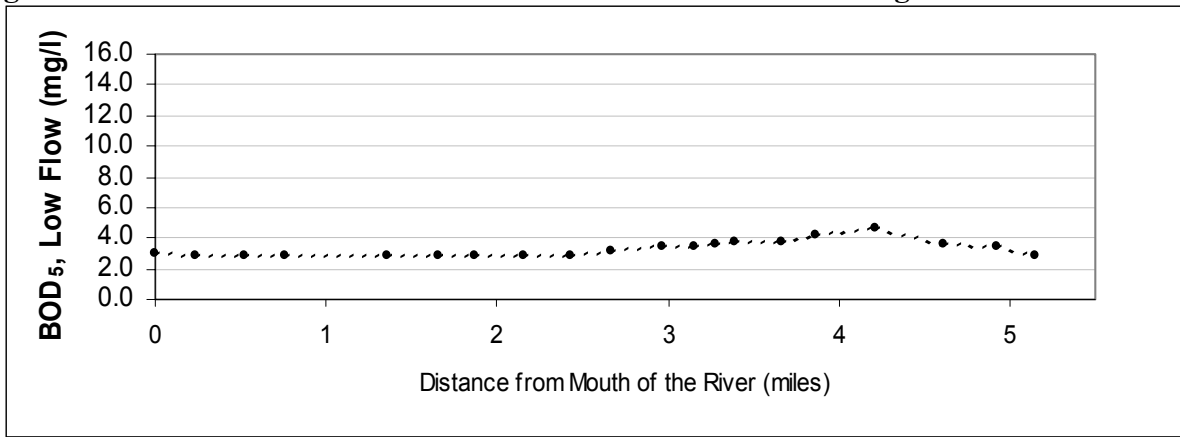

Figure A35: Dissolved Oxygen vs. River Mile for the Baseline Conditions Average Flow Scenario

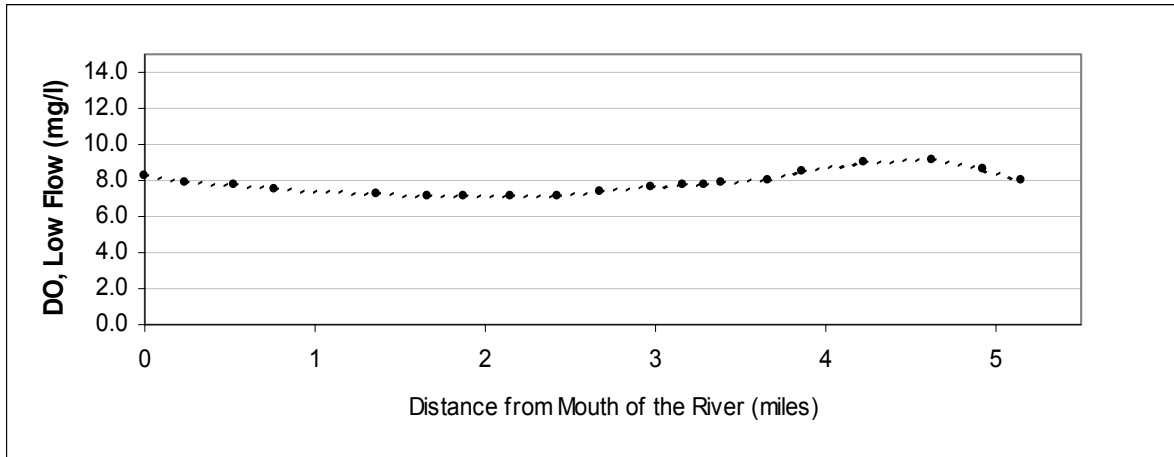
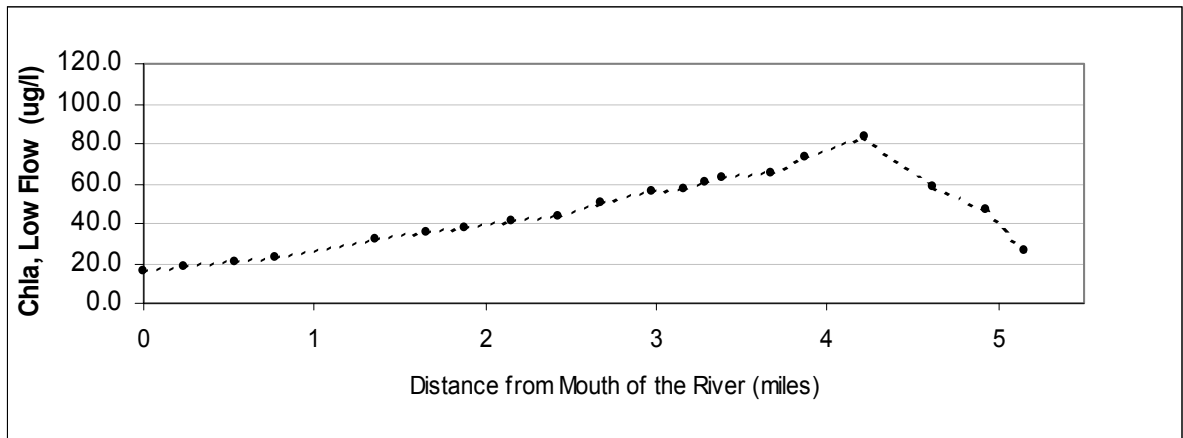

Figure A36: Chlorophyll *a* vs. River Mile for the Baseline Conditions Average Flow Scenario



..... Average Flow Baseline Conditions Scenario

Figure A37: Nitrate (plus Nitrite) vs. River Mile for the Baseline Conditions Average Flow Scenario

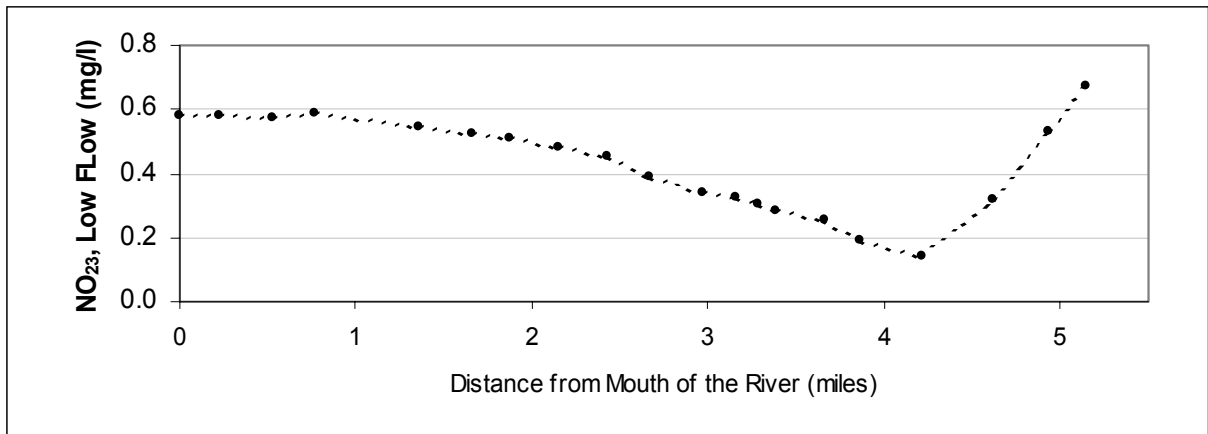

Figure A38: Organic Nitrogen vs. River Mile for the Baseline Conditions Average Flow Scenario

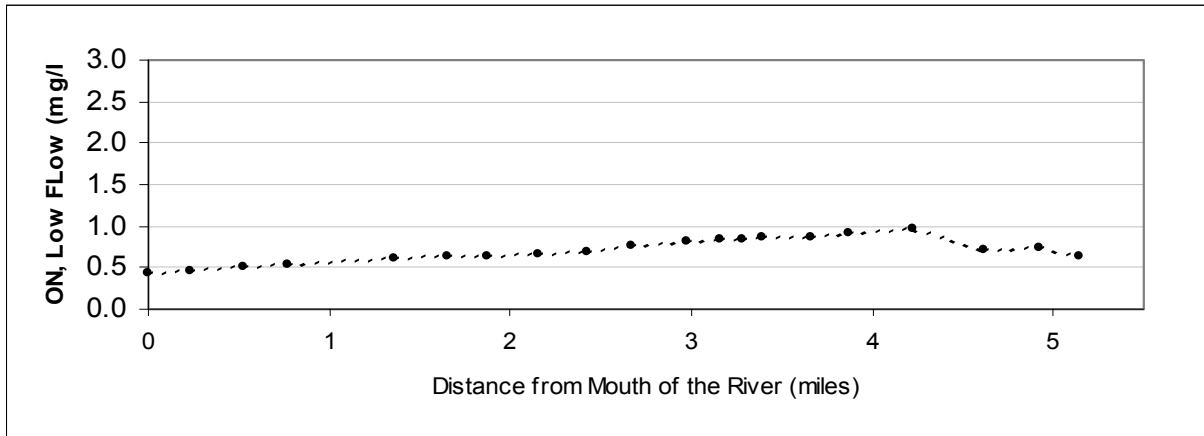
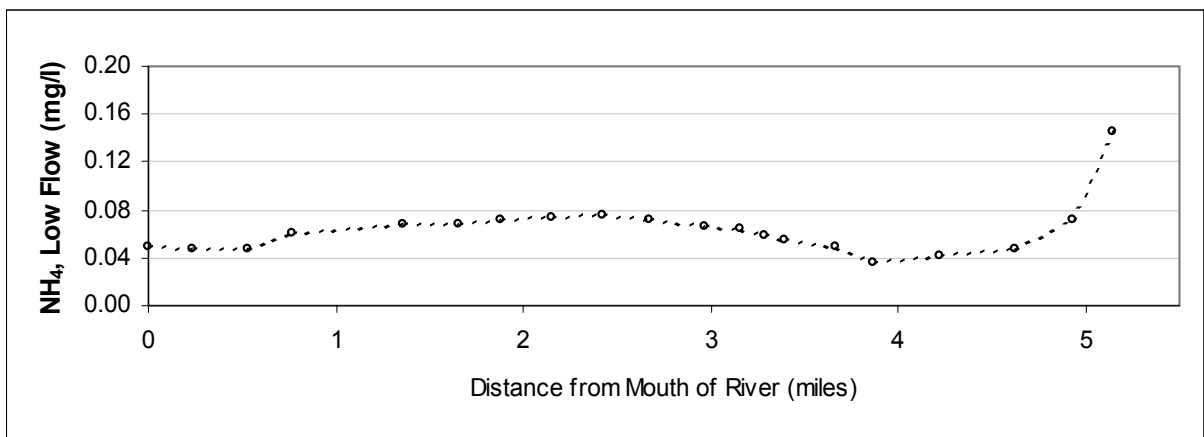

Figure A39: Ammonia vs. River Mile for the Baseline Conditions Average Flow Scenario



..... Average Flow Baseline Conditions Scenario

Figure A40: Organic Phosphorus vs. River Mile for the Baseline Conditions Average Flow Scenario

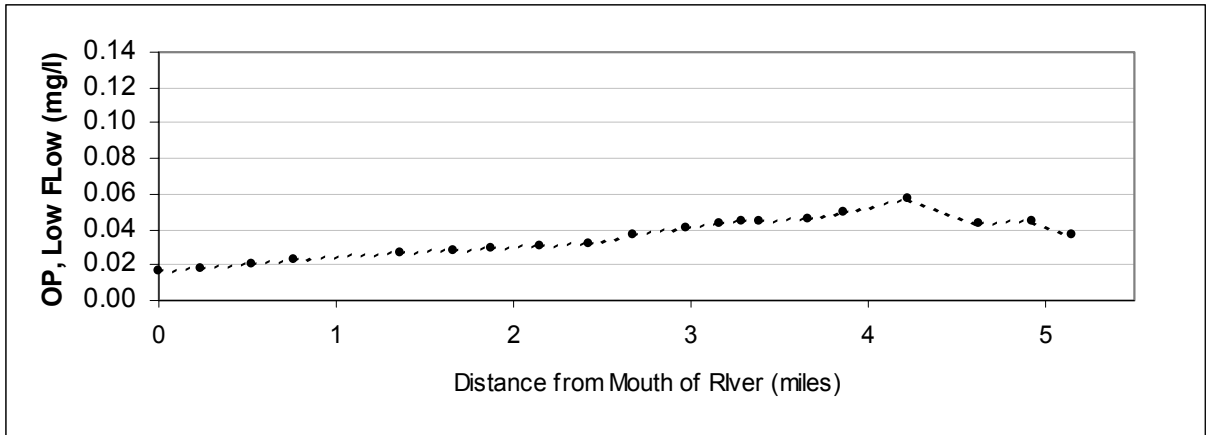
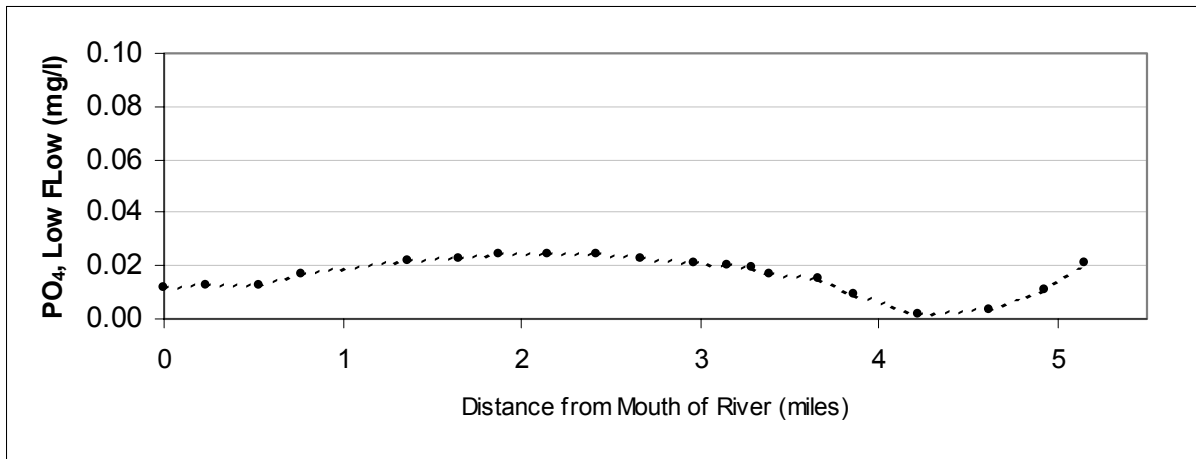

Figure A41: Ortho-Phosphorus vs. River Mile for the Baseline Conditions Average Flow Scenario



Average Flow Baseline Conditions Scenario

.....

Future Low Flow TMDL Scenario Results

Figure A42: BOD vs. River Mile for the Future Low flow TMDL scenario

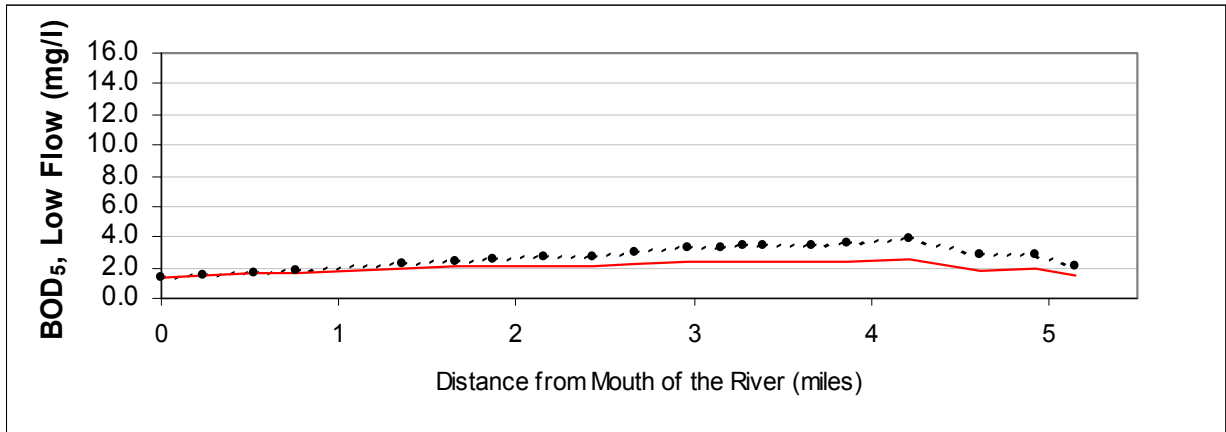

Figure A43: Dissolved Oxygen vs. River Mile for the Future Low Flow TMDL Scenario

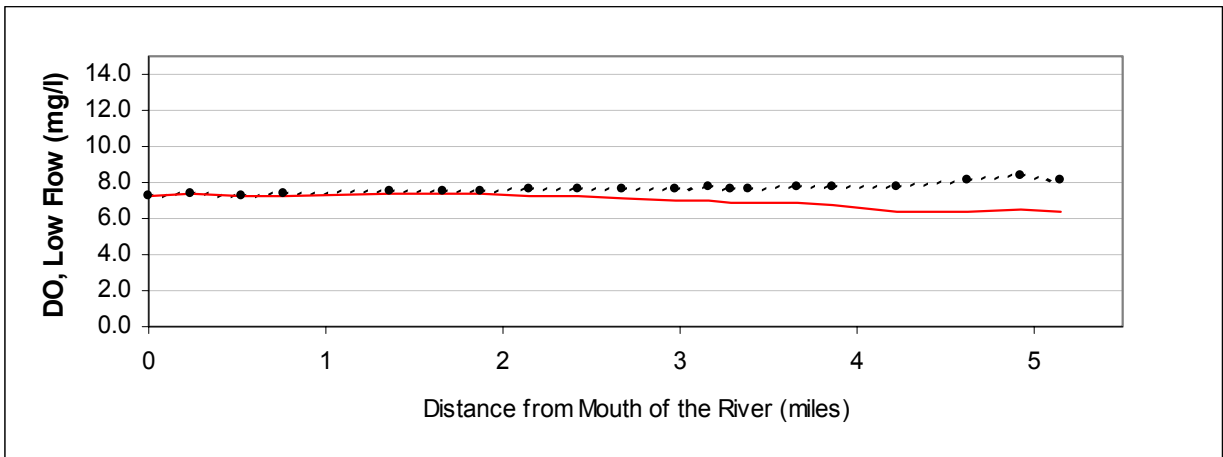
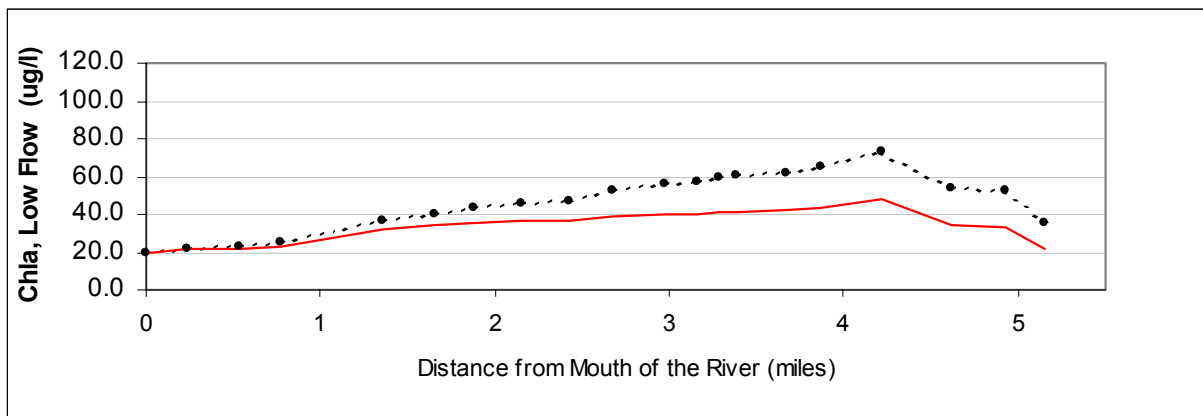

Figure A44: Chlorophyll *a* vs. River Mile for the Future Low Flow TMDL scenario



..... Low Flow Baseline Conditions Scenario — Low Flow Future TMDL Scenario

Figure A45: Nitrate (plus Nitrite) vs. River Mile for the Future Low flow TMDL Scenario

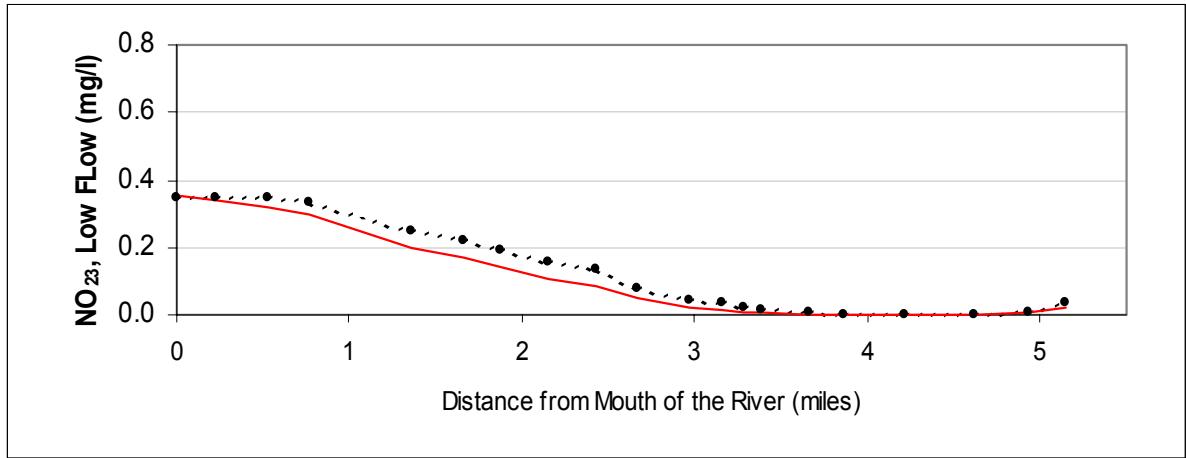

Figure A46: Organic Nitrogen vs. River Mile for the Future Low Flow TMDL Scenario

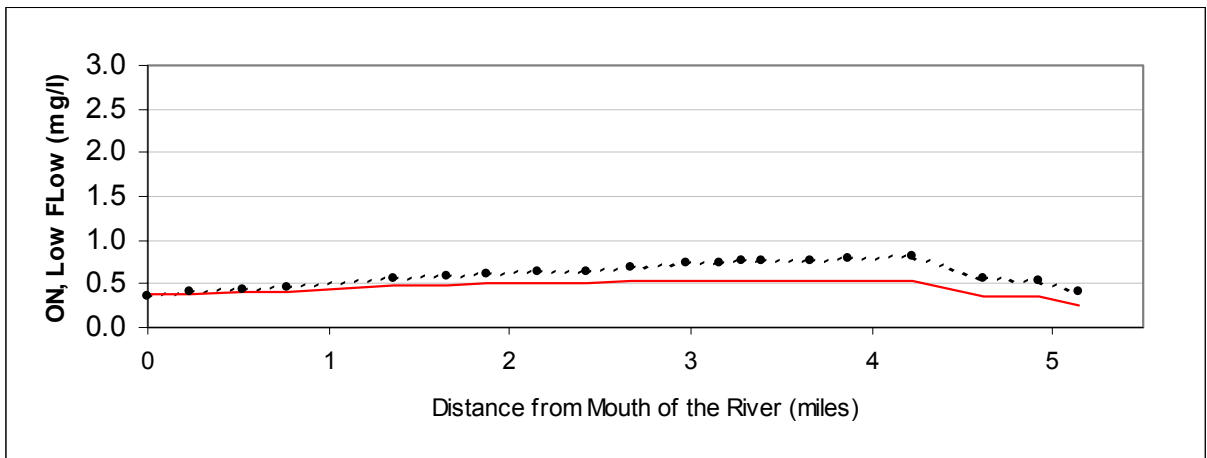
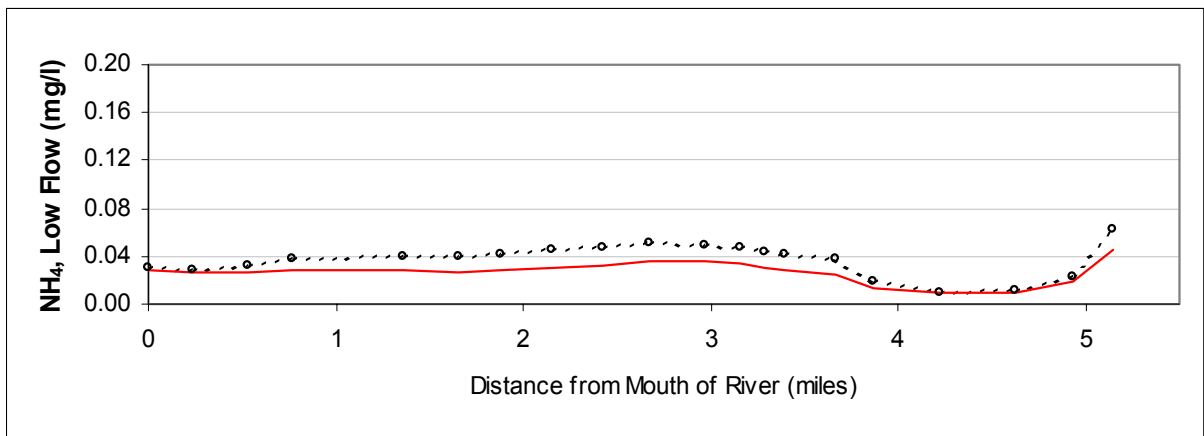

Figure A47: Ammonia vs. River Mile for the Future Low Flow TMDL Scenario



..... Low Flow Baseline Conditions Scenario — Low Flow Future TMDL Scenario

Figure A48: Organic Phosphorus vs. River Mile for the Future Low Flow TMDL Scenario

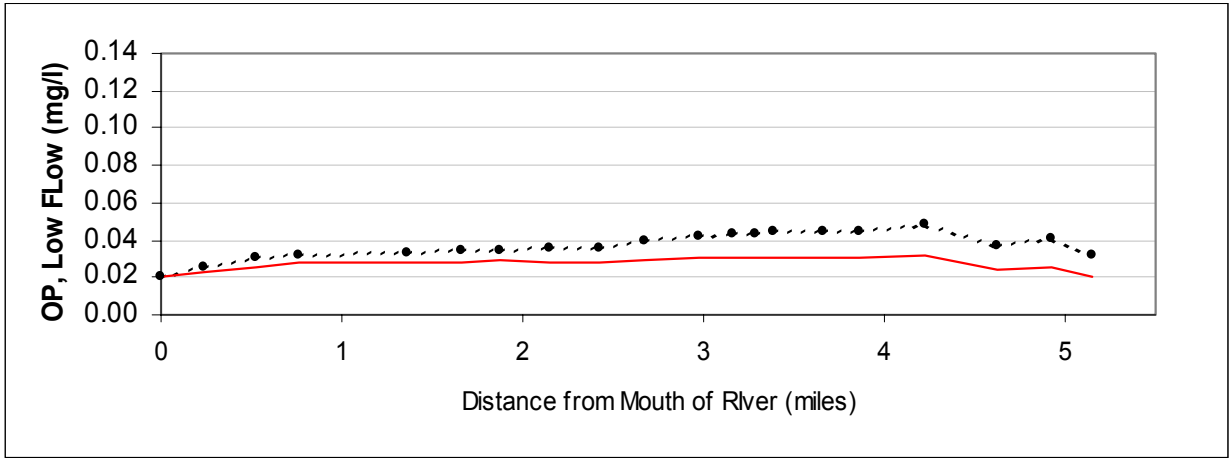
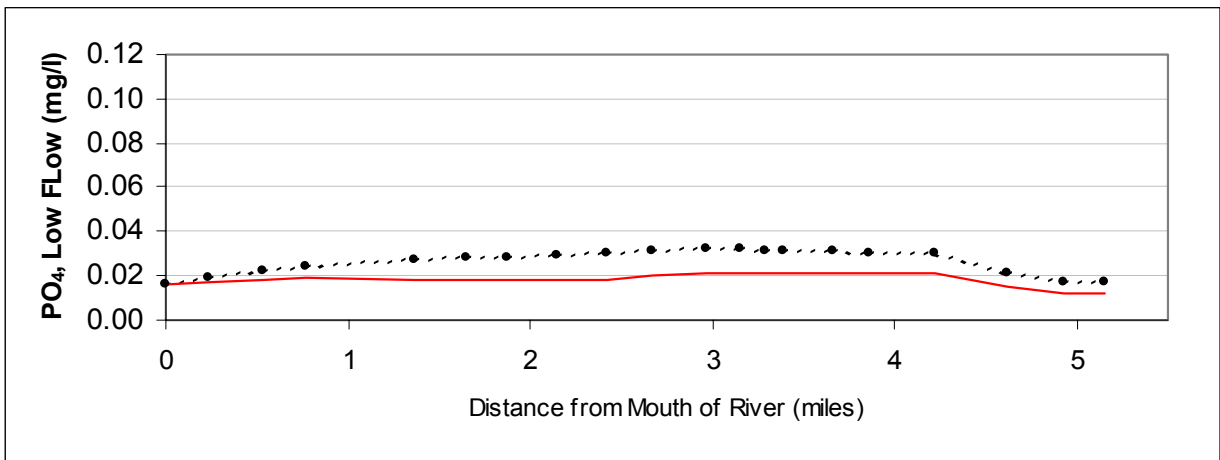

Figure A49: Ortho-Phosphate vs. River Mile for the Future Low Flow TMDL Scenario



..... Low Flow Baseline Conditions Scenario — Low Flow Future TMDL Scenario

Future Average Flow TMDL Scenario Results

Figure A50: BOD vs. River Mile for the Future Average Flow TMDL Scenario

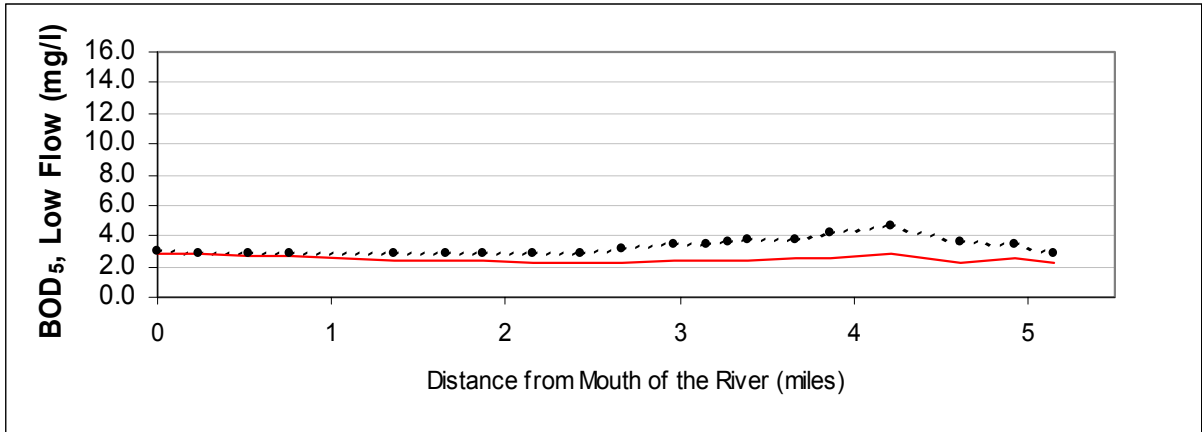

Figure A51: Dissolved Oxygen vs. River Mile for the Future Average Flow TMDL scenario

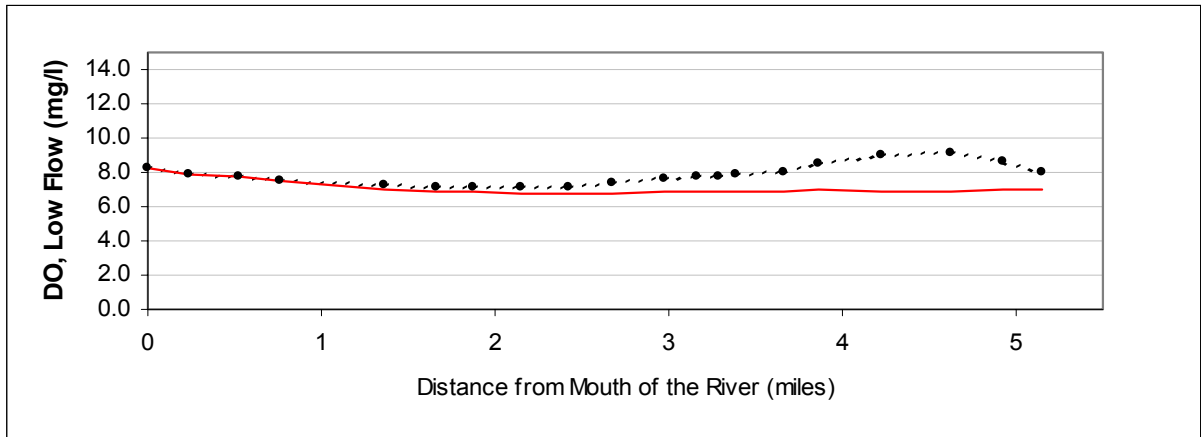
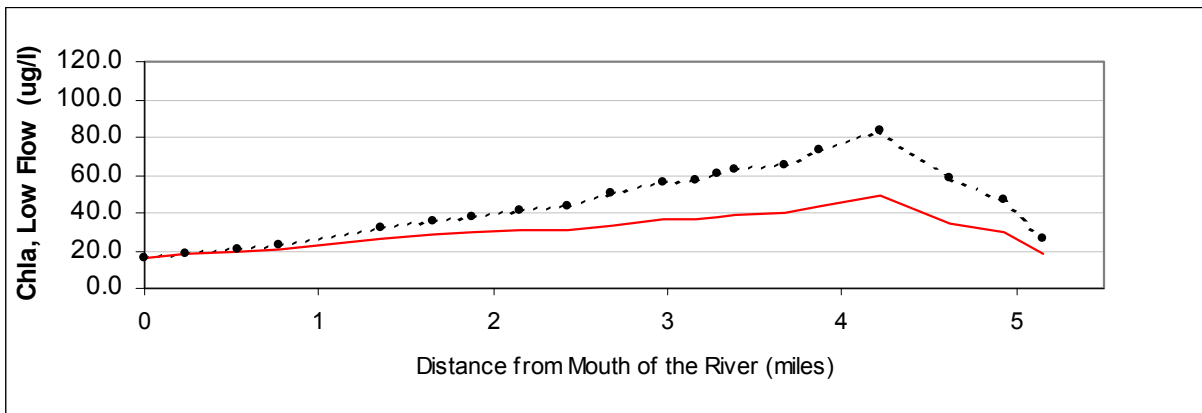

Figure A52: Chlorophyll *a* vs. River Mile for the Future Average Flow TMDL scenario



.....Average Flow Baseline Conditions Scenario — Average Flow Future TMDL Scenario

Figure A53: Nitrate (plus Nitrite) vs. River Mile for the Future Average flow TMDL Scenario

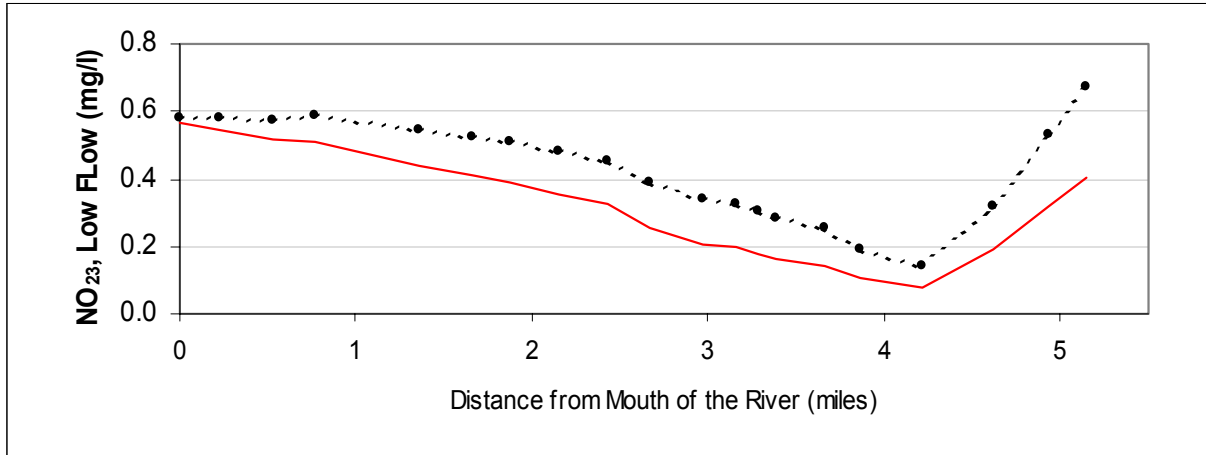

Figure A54: Organic Nitrogen vs. River Mile for the Future Average Flow TMDL Scenario

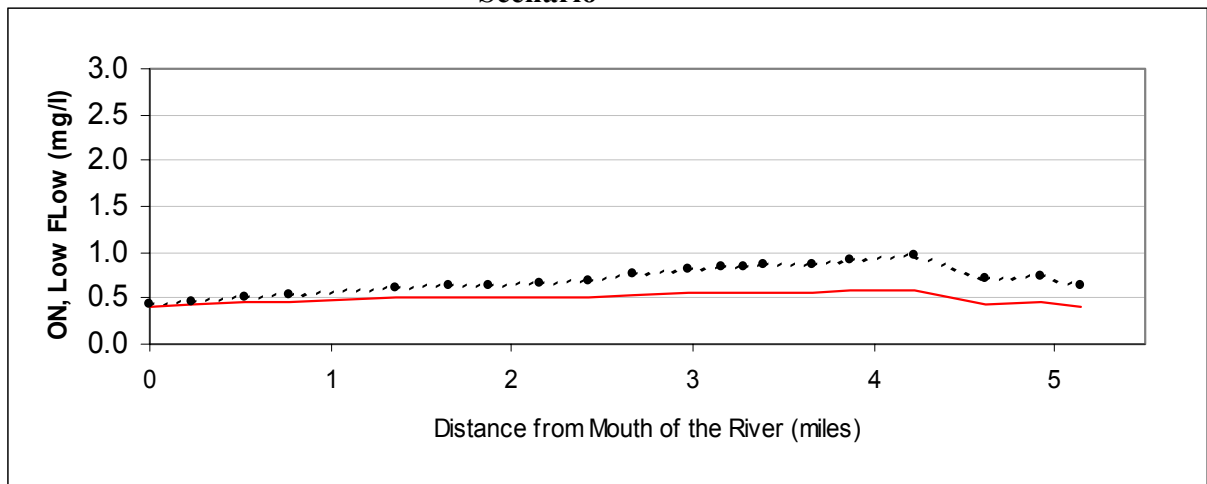
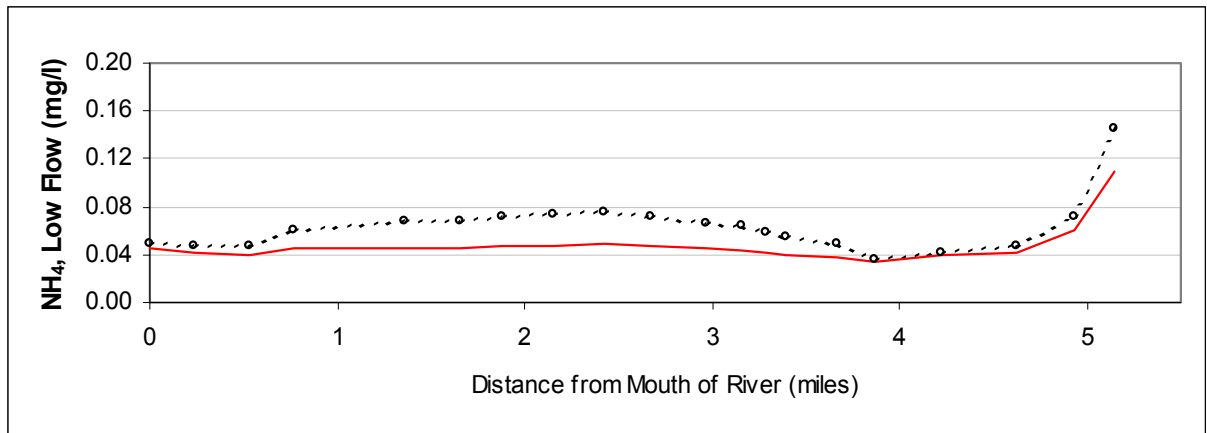

Figure A55: Ammonia vs. River Mile for the Future Average Flow TMDL Scenario



..... Average Flow Baseline Conditions Scenario — Average Flow Future TMDL Scenario

Figure A56: Organic Phosphorus vs. River Mile for the Future Average Flow TMDL Scenario

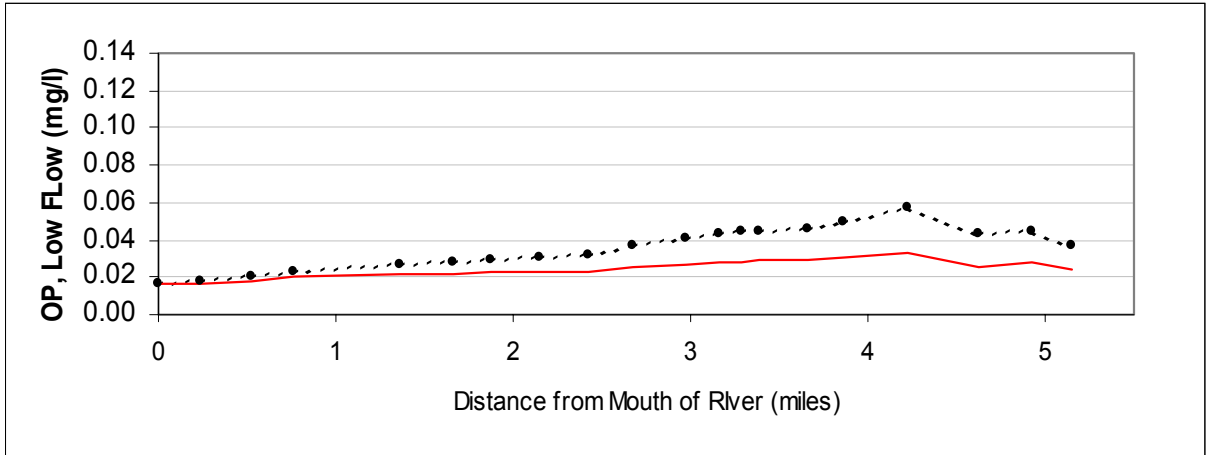
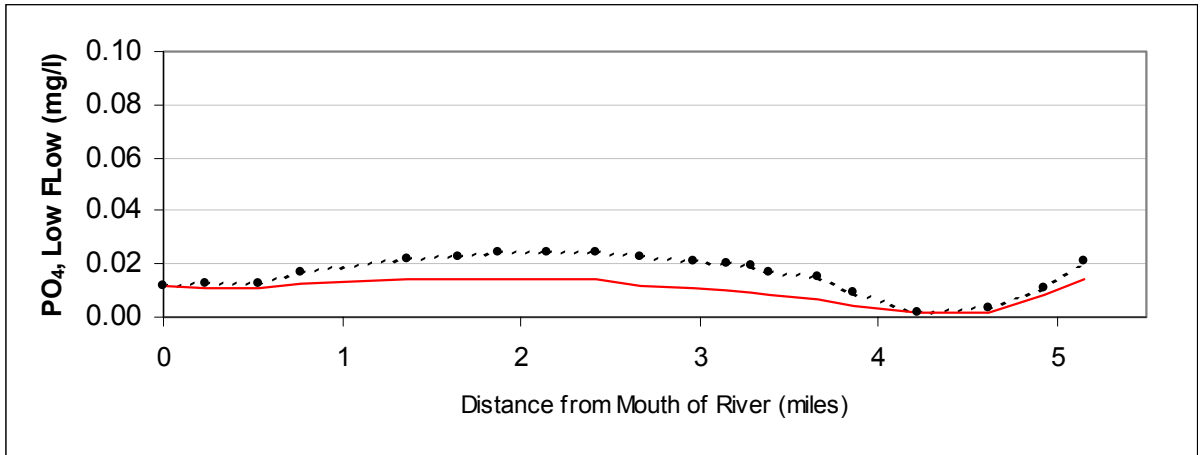

Figure A57: Ortho-Phosphate vs. River Mile for the Future Average Flow TMDL Scenario



..... Average Flow Baseline Conditions Scenario — Average Flow Future TMDL Scenario

REFERENCES

Ambrose, Robert B., Tim A. Wool, James A. Martin. "The Water Quality Analysis Simulation Program, Wasp5". Environmental Research Laboratory, Office Of Research And Development, U.S. Environmental Protection Agency. 1993.

Cerco, Carl F. *Water Quality in a Virginia Potomac Embayment: Gunston Cove*. College of William and Mary, Virginia Institute of Marine Science, Gloucester Point, Virginia. April 1985.

Clark L. J., and S. E. Roesh, *Assessment of 1977 Water Quality Conditions in the Upper Potomac Estuary*. U.S. EPA Annapolis Field Office, Annapolis Maryland. EPA 903/9-78-008, 1978.

Di Toro, D.M., J.J. Fitzpatrick, and R.V. Thomann. *Documentation for Water Quality Analysis Simulation Program (WASP) and Model Verification Program (MVP)*. EPA/600/3-81-044. 1983.

Domotor, Diana K., Michael S. Haire, Narendra N. Panday, and Harry V. Wang. *Mattawoman Creek Water Quality Model*. Technical Report No. 64, Maryland Department of the Environment, Water Management Administration, Modeling and Analysis Division. October 1987.

Institute of Natural Resources, University of Georgia. "Sediment Oxygen Demand – Processes, Modeling & Measurement", Athens, Georgia, 1986

Lung, W. S. *Water Quality Modeling of the Patuxent Estuary*. Final Report to the Maryland Department of the Environment, Water Management Administration, Chesapeake Bay and Special Projects Program, Baltimore, MD. 1993.

Panday, Narendra N., and Michael S. Haire. *Water Quality Assessment of Mattawoman Creek and the Adjacent Potomac River: Summer 1985*. Technical Report No. 52, Water Management Administration, Modeling and Analysis Division, Maryland Office of Programs, Department of Health and Mental Hygiene. September 1986.

Thomann R. V., and J. J. Fitzpatrick. *Calibration and Verification of a Mathematical Model of the Eutrophication of the Potomac Estuary*. HydroQual, Inc. Final Report Prepared for the D.C. Department of Environmental Services, 1982.

U.S. EPA. *Technical Guidance Manual for Developing Total Maximum Daily Loads, Book 2: Streams and Rivers, Part 1: Biochemical Oxygen demand Dissolved Oxygen and Nutrients/Eutrophication*. OW/OWEP and OWRS, Washington, D.C., March, 1997.