

## MODELING FRAMEWORK

The computational framework chosen for the modeling of water quality in the Northeast River was the Water Quality Analysis Simulation Program version 5.1 (WASP5.1). This program provides a generalized framework for modeling contaminant fate and transport in surface waters (Di Toro *et al*, 1983) and is based on the finite-segment approach. It is a very versatile program, capable of being applied in a time-variable or steady state mode, spatial simulation in one, two or three dimensions, and using linear or non-linear estimations of water quality kinetics. To date, WASP5.1 has been employed in many modeling applications that have included river, lake, estuarine and ocean environments. The model has been used to investigate water quality concerns regarding dissolved oxygen (DO), eutrophication and toxic substances. WASP5.1 has been used in a wide range of applications by regulatory agencies, consulting firms, academic researches and others.

WASP5.1 is supported and distributed by U.S. Environmental Protection Agency (EPA)'s Center for Exposure Assessment Modeling (CEAM) in Athens, GA (Ambrose *et al*, 1993). EUTRO5.1 is the component of WASP5.1 that is applicable for modeling eutrophication, incorporating eight water quality constituents in the water column (Figure A1) and sediment bed.

## WATER QUALITY MONITORING

Maryland Department of the Environment (MDE)'s Field Operations Program staff collected water samples for physical and chemical properties on March 3, April 13, May 11, July 20, August 17, and September 14, 1999. The physical parameters, DO, salinity, conductivity, and water temperature were measured *in situ* at each water quality monitoring station. Grab samples were also collected for laboratory analysis. The samples were collected at a depth of 0.5 m from the surface. Samples were placed in plastic bottles and preserved on ice until they were delivered to the University of Maryland Laboratory at Solomons, MD or the Department of Health and Mental Hygiene in Baltimore, MD for analysis. The field and laboratory protocols used to collect and process the samples are summarized in Table A1. Figures A2 – A6 present low flow and high flow water quality profiles along the mainstem of the river.

## MODEL INPUT REQUIREMENTS <sup>1</sup>

### Model Segmentation and Geometry

The spatial domain of the Northeast River Eutrophication Model (NREM) extends from the confluence of Northeast River and the Chesapeake Bay for about 6 miles (9.6 km) up the mainstream of the River. Following a review of the bathymetry for Northeast River, the model was divided into 9 segments (Figure A7). Table A2 lists the volumes, characteristic lengths and interfacial areas of the 9 segments.

---

<sup>1</sup> The WASP model requires all input data to be in metric units, and to be consistent with the model, all data in the Appendix will appear in metric units. Following are several conversion factors to aid in the comparison of numbers in the main document: mgd x (0.0438) = m<sup>3</sup>/s; cfs x (0.0283) = m<sup>3</sup>/s; lb / (2.2046) = kg; mile (0.625) = km; mg/L x mgd x (8.34) / (2.2) = kg/d

### **Dispersion Coefficients**

The dispersion coefficients were calibrated using the WASP5.1 model and in-stream water quality data from 1999. The WASP5.1 model was set up to simulate salinity. Salinity is a conservative constituent, meaning there are no losses due to reactions in the water. The only source in the system is the salinity from the water at the tidal boundary at the mouth. For model execution, salinity values at all boundaries, except the tidal boundary, were set to zero. Flows for both low flow and high flow regimes were obtained from statistical regression analysis using data from a USGS gage station located in Cecil County, Maryland (see the section on Freshwater Flows for more details). Figure A8 represents a longitudinal profile of salinity data collected in 1999. Figure A9 shows the data used for calibration and the model output for the low flow period in 1999. Due, in great part, to fresh water intrusions from the Susquehanna River, the salinity profiles are unstable for some period, or showed a reverse gradient in salinity from the river mouth to the riverhead. For this reason, dispersion coefficients were calibrated against salinity data collected in August 1999 only and observed data collected in July and September (low flow) as well as March, April, May (high flow) was excluded from the model calibration process. Dispersion coefficients are listed in Table A3.

### **Freshwater Flows**

Freshwater flows were calculated on the basis of delineating the Northeast River drainage basin into 11 subwatersheds (Figure A10). These subwatersheds closely correspond with the Maryland Department of Natural Resources 12-digit basin codes. Where necessary, the subwatersheds were refined to assure they were consistent with the 9 segments developed for the NREM. The NREM was calibrated for two sets of flow conditions: high flow and low flow. The high flow corresponds to the month of May 1999, and the low flow corresponds to the month of August 1999.

The flows for the subwatersheds were estimated from a regression statistical analysis using the August 1999 and the average annual flow data from the USGS gage #01495000 located near the Northeast River. A ratio of flow to drainage area was calculated for the subwatershed draining into gage #0149500 and then that ratio was multiplied by the area of the Northeast's subwatersheds to estimate the high and low flows. For both high flow and low flow, each subwatershed was assumed to contribute a flow to the Northeast River mainstem. These flows and loads were assumed to be direct inputs to the NREM. Table A4 presents flows from different subwatersheds during low flow, critical low flow (7Q10), high flow and average annual flow conditions.

The critical low flow or 7Q10 is used to investigate the critical flow conditions under which symptoms of eutrophication are typically most acute (late summer when flows are low, system is poorly flushed and when sunlight and temperatures are most conducive to excessive algal production). The 7Q10 refers to the lowest consecutive 7-day streamflow that is likely to occur in a ten-year period. It is used by many states and the federal government in setting discharge limits in NPDES water quality permits. A permit will only be granted if the proposed amount of pollutant that will be discharged into a river will not significantly impair the designated uses when the streamflow falls to the 7Q10 level.

The average annual flow is used to model annual average loadings and represents "average" stream conditions, which is likely to occur during other months of the year. When modeling both low flow and average annual flow, the analyses account for seasonality.

### **Nonpoint Source Loadings**

Nonpoint source loadings were estimated for low flow and average annual flow conditions. For nonpoint sources, the concentrations of the nutrients nitrogen and phosphorus are modeled in their speciated forms. The WASP5.1 model simulates nitrogen as ammonia (NH<sub>3</sub>), nitrate and nitrite (NO<sub>2-3</sub>), organic nitrogen (ON), phosphorus as ortho-phosphate (PO<sub>4</sub>), and organic phosphorus (OP). NH<sub>3</sub>, NO<sub>2-3</sub>, and PO<sub>4</sub> represent the dissolved forms of nitrogen and phosphorus. The dissolved forms of nutrients are more readily available for biological processes, such as algal growth, that can affect chlorophyll *a* (Chl*a*) levels and DO concentrations.

Loads for the low flow calibration and for the annual average flow scenario were estimated as the product of the concentrations observed during 1999, and multiplied by their respective estimated flows. Water quality data from the 1999 survey was used to estimate boundary concentrations as follows: the average of Stations XKI1809 and XKI2203 was used for Segment 1; Station NOC0008 was used for Segment 9; and the average of Stations LNE0008, NOC0053, LNE0052 and NOC0113 was used for Segments 3, 4, 6, 7 and 8. The locations of these water quality stations are shown in Figure 1 and Table 1 of the main document.

For the low flow scenario, only August 1999 data was used. Annual average loads were estimated by averaging all MDE data taken during the 1999 surveys.

The loads used for the calibration of the model and the loads used in the annual average flow scenario, both reflect natural and human sources, including atmospheric deposition, loads coming from septic tanks, loads coming from urban development, agriculture, and forestland.

### **Point Source Loadings**

For the point source loadings, the concentrations of the nutrient parameters simulated by the model are considered in the same speciated forms as described above. The Northeast River Waste Water Treatment Plant (WWTP) and the Morning Cheer WWTP discharge directly into Northeast River (water quality model segments 5 and 4, respectively).

The point sources loading used in the calibration of the model was calculated from actual WWTP flows and concentrations stored in MDE's point source database. For higher stream flow conditions, point source loads were simulated as an average of May 1999 discharge reports data. For low flow stream conditions, point source loads were simulated as an average of August 1999 discharge report data. These data coincide with the time period in which data was collected and used for model calibration. Table A5 presents the point source flows and loadings used for the model calibration.

The point source loadings used for the baseline low flow scenario (first scenario) and for the baseline average annual flow scenario (second scenario) were calculated from the maximum allowable effluent concentrations' limits described in the plant's surface water discharge National Pollutant Discharge Elimination System (NPDES) permit (see scenario descriptions below). For model input parameters for which there is no permit limit, concentrations were estimated based on the type of unit operations or treatment processes used by each plant under consideration.

### **Environmental Conditions**

Seven environmental parameters were used for developing the model of the Northeast River. They are solar radiation and photoperiod (see Table A6), temperature (T), extinction coefficient ( $K_e$ ), salinity, sediment oxygen demand (SOD), sediment ammonia flux (FNH<sub>4</sub>) and sediment phosphate flux (FPO<sub>4</sub>) (Table A7).

Data for the solar radiation and photoperiod were taken from a water quality model study performed on the Potomac River in 1982 (Thomann and Fitzpatrick, 1982). Data for salinity and temperature were taken from in-stream water quality measurements. Initial values of SOD, FNH<sub>4</sub> and FPO<sub>4</sub> were estimated then refined through the calibration process.

The light extinction coefficient,  $K_e$  in the water column was derived from Secchi depth measurements taken during the water quality surveys and using the following equation:

$$K_e = \frac{1.95}{D_s}$$

where:

$K_e$  = light extinction coefficient ( $m^{-1}$ )

$D_s$  = Secchi depth ( $m$ )

It was estimated that phytoplankton and nonliving organic nutrient components settle from the water column to the sediment at an estimated settling velocity of 0.00864  $m/day$  ( $1E10^{-7} m/sec$ ). These values are within the range specified in the WASP5.1 manual. In general, it is reasonable to assume that 50% of the nonliving organics are in the particulate form.

Different SOD values were estimated for different NREM reaches based on observed environmental conditions and literature values (Thomann and Mueller, 1987). For the low flow regime an SOD value of 1.0  $gO_2/m^2day$  was assumed to occur throughout the length of the river. A lower value of 0.5  $gO_2/m^2day$  was assumed for the high flow regime (see Table A7).

### **Kinetic Coefficients**

The water column kinetic coefficients are universal constants used in the NREM model. They are formulated to characterize the kinetic interactions among the water quality constituents. The initial values were taken from past modeling studies of Potomac River (Clark and Roesh, 1978;

Thomann and Fitzpatrick, 1982; Cerco, 1985), and of Mattawoman Creek (Panday and Haire, 1986; Domotor *et al.*, 1987), and the Patuxent River (Lung, 1993), and the Chesapeake Bay (Cerco and Cole, 1994; Cerco, Johnson and Wang, 2002). The kinetic coefficients are listed in Table A8.

### **Initial Conditions**

The initial conditions used in the model were chosen to reflect the observed values as closely as possible. However, because this is a steady-state model, the initial conditions will not impact the final results.

## **CALIBRATION & SENSITIVITY ANALYSIS**

The NREM model for salinity, which was used to estimate the dispersion coefficients, was calibrated with August 1999 salinity data. Figure A9 shows the salinity calibration only for the low flow period, because salinity concentrations for the high flow period were close to 0. More information about the dispersion coefficients can be found in the *Model Input Requirements* section above.

The NREM model for low flow was calibrated with August 1999 data. Tables A9, A10 and A11 show the nonpoint source flows and loads associated with the calibration input file (See *Point and Nonpoint Sources Loadings* above for details). Figures A11 – A18 show the results of the calibration of the model for low flow. The results show that the chlorophyll *a*, 5-day biological oxygen demand (BOD<sub>5</sub>) and DO trends are represented well, and overall the trend is captured.

The NREM model for high flow was calibrated with May 1999 data. The results are presented in Figures A19 to A26. As can be seen, the model represents the chlorophyll *a* very well and all other parameters also follow the trend of the observed data.

Model sensitivity analyses were performed on the calibration and on the baseline condition scenarios for low flow and average annual flow to determine the reaction of the model to reductions in both nitrogen and phosphorus. The model was sensitive to reductions in both nitrogen and phosphorus.

## **SYSTEM RESPONSE**

The NREM model was applied to several different Point and Nonpoint Sources loading conditions under various stream flows to project the impacts of nutrients on algal production (modeled as chlorophyll *a*) and low DO. By simulating various stream flows, the analysis accounts for seasonality.

## Model Run Descriptions

### Baseline Condition Scenarios:

*First Scenario (Low Flow):* The first scenario represents the baseline low flow conditions of the stream. The low flow was estimated using a regression analysis as described above for the USGS stations specified above in the Freshwater Flows section. The nonpoint source loads for this scenario were the same nonpoint source loads used in the low flow calibration of the model and computed as described above in the Nonpoint Source Loads Section. These nonpoint source loads are shown in Table A10. Because the loads are based on observed concentrations, they account for all background and human-induced sources. All the environmental parameters used for the first scenario remained the same as those of the low flow calibration of the model. The point sources used in this scenario were calculated as described above in the section “Point Source Loadings” and are shown in Table A12.

*Second Scenario (Average Annual Flow):* The second scenario represents the baseline conditions of the stream during average annual flow. The total average annual flow was estimated based on data from the USGS gages as described above. Nonpoint source load estimation methods are described above. Nonpoint source concentrations for this scenario are shown in Table A14. Point source loadings were the same used in the first scenario. All the environmental parameters remained the same as in the first scenario - except temperature. Temperature for this scenario was estimated by averaging the maximum summer temperatures from the Chesapeake Bay Program 12-year historical data in the Maryland Eastern Shore area. This summer maximum average temperature, 28.8°C, was used for all segments in the tidal and nontidal portions of the river.

### Future Condition TMDL Scenarios:

*Third Scenario (Low Flow):* The third scenario is the final result of a number of iterative model scenarios involving nutrient reductions that were explored to determine the maximum allowable loads during low flow conditions. For this scenario, the flow was the same as Scenario 1. The total nonpoint source loads from the first scenario, based on the 1999 MDE field data, were reduced to meet the water quality criteria specified before. A 5% of the total NPS loads was reserved for future allocation and a 3% of total NPS loads was included for margin of safety in the load calculation. The point source loads reflect the plant’s maximum water and sewer plant design flow and reduced effluent concentrations. All the environmental parameters and kinetic coefficients used for the calibration of the model remained the same as scenario one (except nutrient fluxes). A description of the methods used to estimate the reductions of nonpoint and point sources, as well as nutrient fluxes and SOD for this scenario, are described in the following paragraphs.

- To estimate feasible nitrogen and phosphorus nonpoint source reductions, the percent of the nonpoint source load that is controllable was estimated for each subwatershed. It was assumed that all of the loads from cropland, feedlots, and urban were controllable, and loads from atmospheric deposition, septic tanks, pasture, and forest were not controllable. The percent controllable was applied to the low flow loads as well as the average annual loads. A

margin of safety of 3% was included in the load calculation. Using the above calculated percent controllable, several iterative reductions were made to the nonpoint source loadings starting with a 10% reduction of controllable nutrient loads up to the final nitrogen and phosphorus reductions used for the future low flow condition scenario. These reductions in nonpoint source loads, combined with the reduced point source loads from the baseline conditions scenario, meet the chlorophyll *a* goal of 50 µg/L, and the DO criterion of no less than 5.0 mg/L. The nonpoint source flows and concentrations for model Scenario 3 can be seen in Table A14.

- 
- The point sources loads were estimated using the plant's maximum design flow and reduced effluent concentrations. The nitrogen and phosphorus loads were reduced from the first scenario "baseline conditions" to meet the chlorophyll *a* goal of 50 µg/l, and the dissolved oxygen criterion of no less than 5.0 mg/l. Modeling input assumed the reduction would be implemented at major point sources (Design flow > 0.5 million of gallons per day) under anticipated summer operating conditions. The point sources have maximum flows of 2.0 and 0.055 million gallons per day for Northeast River WWTP and Morning Cheer WWTP respectively as noted in the main document. More information about point source loads can be found in the technical memorandum entitled "*Significant Nutrients Point Sources in the Northeast River Watershed*".
- The reduction in nutrients also affects the baseline boundary concentrations of chlorophyll *a* in the river for the model run. The amount of nitrogen and phosphorus available for algal growth was calculated after the reduction in nutrient loads to help estimate the amount of chlorophyll *a* entering the model's boundaries. For the model scenarios in which the nutrient loads to the system were reduced, a method was developed to estimate the reductions in nutrient fluxes and SOD from the bottom sediment layer. First, an initial estimate was made of the total organic nitrogen and organic phosphorus settling to the river bottom, from particulate organic nutrients, living algae, and phaeophytin, in each segment. This was done by running the baseline condition scenario once with estimated settling of organics and chlorophyll *a*, then again with no settling. The difference in the amount of organic matter between the two runs was assumed to settle to the river bottom where it would be available as a source of nutrient flux and SOD. All phaeophytin was assumed to settle to the bottom. The amount of phaeophytin was estimated from in-stream water quality data. This analysis was then repeated for the reduced nutrient loading conditions. The percentage difference between the amount of nutrients that settled in the baseline condition scenarios and the amount that settled in the reduced loading scenarios was then applied to the nutrient fluxes in each segment. The reduced nutrient scenarios were then run again with the updated fluxes. A new value of settled organics was calculated, and new fluxes were calculated. The process was repeated several times, until the reduced fluxes remained constant.
- It was assumed that the SOD values were the same as in the baseline scenario (1.0 gO<sub>2</sub>/m<sup>2</sup> day).

*Fourth Scenario (Average Annual Flow)*: The fourth scenario represents improved conditions associated with the maximum allowable loads to the stream during average annual flow. The

flow was the same as in the second scenario. The nitrogen and phosphorus loads were reduced from the second scenario (average annual flow baseline scenario) to meet chlorophyll *a* and DO goals in the same way as in the third scenario. A 5% of the total NPS loads for future allocation and a 3% of total NPS loads for margin of safety were also included in the load calculation. All environmental parameters and kinetic coefficients used for the calibration of the model (except nutrient fluxes) remained the same as in the second scenario. The nonpoint source loads for model Scenario 4 can be seen in Table A15.

## Scenario Results

### Baseline Condition Scenarios:

*First Scenario (Low Flow):* The first scenario simulates the summer low flow conditions with maximum allowable loads from point sources as described above. The results for this first scenario can be seen in Figures A27-A34. As shown in the figures, the peak chlorophyll *a* level is 83.2 µg/l, which is above the management goal of 50 µg/l. The dissolved oxygen level is above the water quality criterion of 5.0 mg/l throughout the length of the Northeast River.

*Second Scenario (Average Annual Flow):* The second scenario simulates average stream flow conditions with average annual nonpoint source loads with reduced loads from point sources estimated as described above. Results for this scenario, representing baseline conditions for average stream flow and loads, are summarized in Figures A35-A42. Under these conditions, the chlorophyll *a* concentrations are also above the desired goal of 50 µg/l with a maximum of 92.4 µg/l. The DO concentrations remain above the 5.0 mg/l criterion throughout the length of the Northeast River.

### Future Condition TMDL Scenarios:

The NREM calculates the daily average, minimum, and maximum DO concentrations in the stream. Accounting only for the daily average DO concentrations is not necessarily protective of water quality when one considers the effects of diurnal DO variation due to photosynthesis and algal respiration. The photosynthetic process utilizes radiant energy from the sun to convert water and carbon dioxide into glucose and oxygen. Because the photosynthetic process is dependent on solar radiant energy, the production of oxygen proceeds only during daylight hours. Concurrently with this production, however, the algae require oxygen for respiration, which proceeds continuously. Minimum values of dissolved oxygen usually occur in the early morning predawn hours when the algae have been without light for the longest period of time. Maximum values of DO usually occur in the early afternoon. The diurnal range (maximum minus minimum) may be large and if the daily mean level of DO is low, minimum values of dissolved oxygen during a day may approach zero creating a potential for a fish kill. Thus, for the rest of the model results, the minimum dissolved oxygen concentration is reported, to make sure that the chlorophyll *a* concentrations due to the TMDL loadings will not lower the DO concentrations below the standard of 5.0 mg/l.

*Third Scenario (Low Flow):* The third scenario simulates the future condition of maximum allowable loads for critical low stream flow conditions during the summer season. The results of



this scenario (solid line) are shown in Figures A43-A50 in comparison to the corresponding baseline low flow scenario (dotted line). Under this nutrient load reduction condition, the water quality targets for DO and chlorophyll *a* are met at all locations in Northeast River.

To achieve the targeted goals, a reduction of 44% of total nitrogen from controllable loads in all 9 subwatersheds was made and point sources were set with new allowable nitrogen loads, and a 42 % reduction of total phosphorus from controllable loads was made with new point sources allowable phosphorus loads. Point sources at the Northeast WWTP were set at 8 mg/l for total nitrogen and at 1 mg/l for total phosphorus. No reductions were made at the Morning Cheer WWTP concentrations.

*Fourth Scenario (Average Annual Flow)*: The fourth scenario simulates the future condition of maximum allowable loads under average stream flow and average annual loading conditions. The results for this scenario (solid line) are summarized and compared to the corresponding base-line annual average flow scenario (dotted line) in Figures A51-A58. Again the target water quality goals for DO (greater than 5 mg/l) and chlorophyll *a* (less than 50  $\mu\text{g/l}$ ) are met for the entire length of Northeast River.

According to the baseline, defined by the 1999 MDE observed data, a total nitrogen reduction from controllable nonpoint source loads of 48 % was made and point sources were set with new allowable loads. A 48% reduction of phosphorus loads from controllable nonpoint sources was also made at all 9 subwatersheds to achieve the target water quality goals. Point source concentrations at the Northeast WWTP were set at 8 mg/l for total nitrogen and at 1 mg/l for total phosphorus. No reductions were made at the Morning Cheer WWTP concentrations.

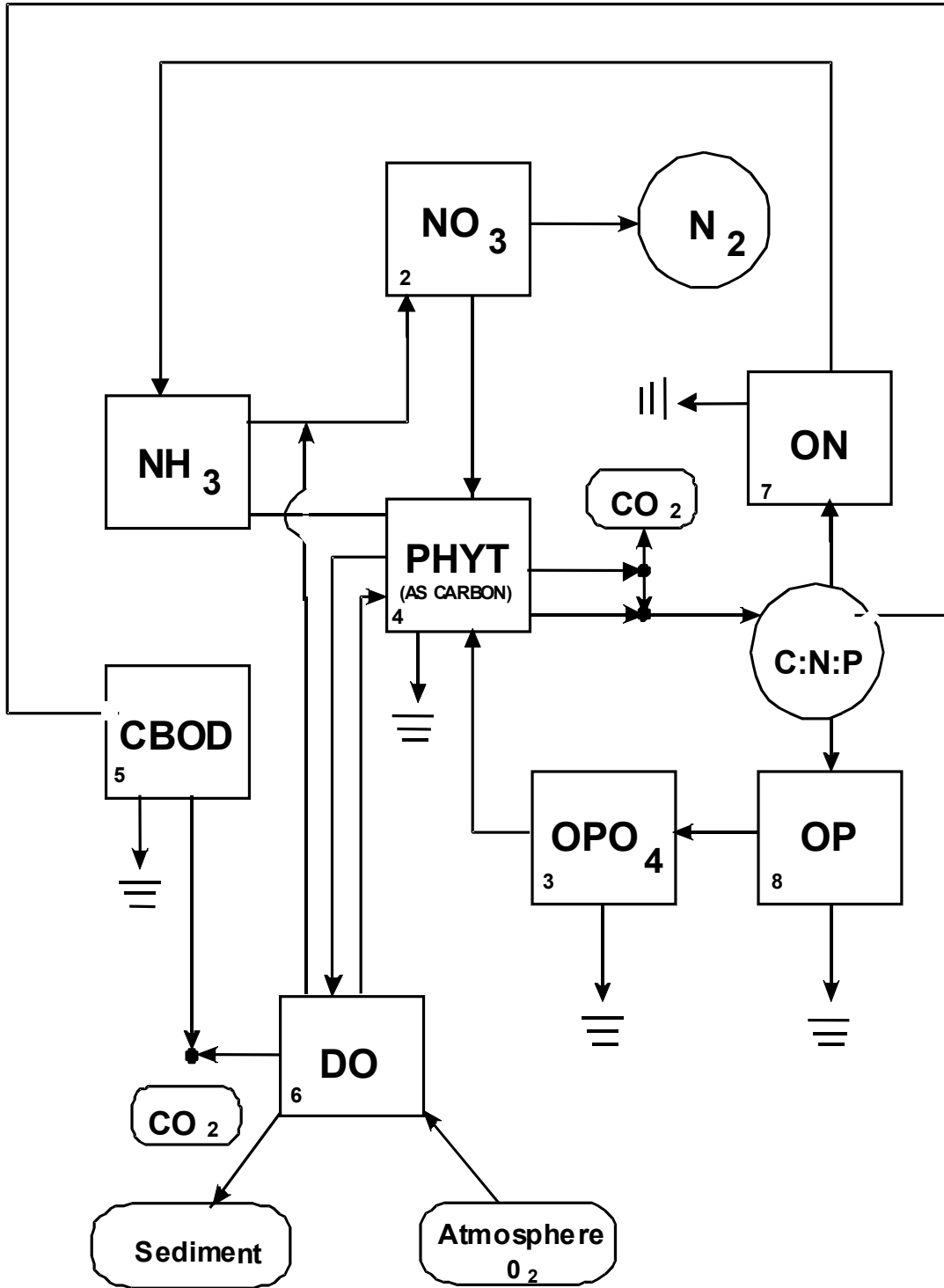
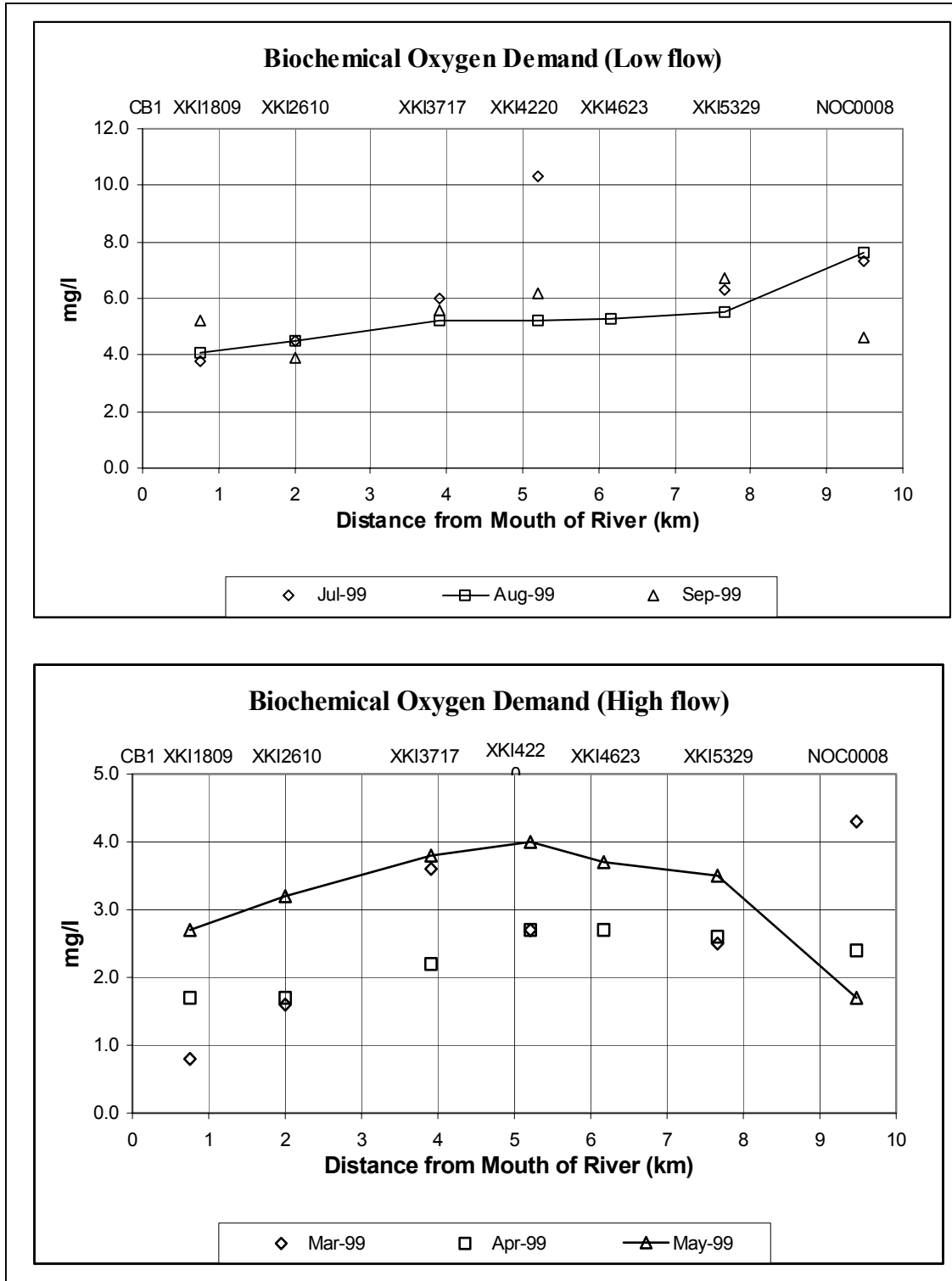

Figure A1: State Variables and Kinetic Interactions in EUTRO5

**Table A1: Field and Laboratory Protocols**

<b>Parameter</b>	<b>Units</b>	<b>Detection Limits</b>	<b>Method Reference</b>
<b>IN SITU:</b>			
Flow	cfs	0.01 cfs	Meter (Marsh-McBirney Model 2000 Flo-Mate)
Temperature	degrees Celsius	-5 deg. C to 50 deg. C	Linear thermistor network; Hydrolab Multiparameter Water Quality Monitoring Instruments Operating Manual (1995) Surveyor 3 or 4 (HMWQMIOM)
Dissolved Oxygen	mg/L	0 to 20 mg/l	Au/Ag polarographic cell (Clark); HMWQMIOM
Conductivity	micro Siemens/cm ( $\mu\text{S}/\text{cm}$ )	0 to 100,000 $\mu\text{S}/\text{cm}$	Temperature-compensated, five electrode cell Surveyor 4; or six electrode Surveyor 3 (HMWQMIOM)
pH	pH units	0 to 14 units	Glass electrode and Ag/AgCl reference electrode pair; HMWQMIOM
Secchi Depth	meters	0.1 m	20.3 cm disk
<b>GRAB SAMPLES:</b>			
Ammonium	mg N / L	0.003	Chesapeake Biological Laboratory. Standard Operating Procedures. TR No. 158-97
Nitrate + Nitrite	mg N / L	0.0007	Chesapeake Biological Laboratory. Standard Operating Procedures. TR No. 158-97
Nitrite	mg N / L	0.0003	Chesapeake Biological Laboratory. Standard Operating Procedures. TR No. 158-97
Total Dissolved Nitrogen	mg N / L	0.03	Chesapeake Biological Laboratory. Standard Operating Procedures. TR No. 158-97
Particulate Nitrogen	mg N / L	0.0123	Chesapeake Biological Laboratory. Standard Operating Procedures. TR No. 158-97
Ortho-phosphate	mg P / L	0.0007	Chesapeake Biological Laboratory. Standard Operating Procedures. TR No. 158-97
Total Dissolved Phosphorus	mg P / L	0.0015	Chesapeake Biological Laboratory. Standard Operating Procedures. TR No. 158-97
Total Phosphorus	mg P / L		Chesapeake Biological Laboratory. Standard Operating Procedures. TR No. 158-97
Particulate Phosphorus	mg P / L	0.0024	Chesapeake Biological Laboratory. Standard Operating Procedures. TR No. 158-97
Dissolved Organic Carbon	mg C / L	0.15	Chesapeake Biological Laboratory. Standard Operating Procedures. TR No. 158-97
Particulate Carbon	mg C / L	0.0759	Chesapeake Biological Laboratory. Standard Operating Procedures. TR No. 158-97
Silicate	mg Si / L	0.01	Chesapeake Biological Laboratory. Standard Operating Procedures. TR No. 158-97
Total Suspended Solids	mg / L	2.4	Chesapeake Biological Laboratory. Standard Operating Procedures. TR No. 158-97
Chlorophyll <i>a</i>	$\mu\text{g}/\text{L}$	1 mg/cu.M	Standard methods for the Examination of Water and Wastewater (15 <sup>th</sup> ed.) #1002G. Chlorophyll. Pp 950-954
BOD <sub>5</sub>	mg/l	0.01 mg/l	Oxidation ** EPA No. 405



**Figure A2: Longitudinal Profile of Biological Oxygen Demand (BOD) Data**

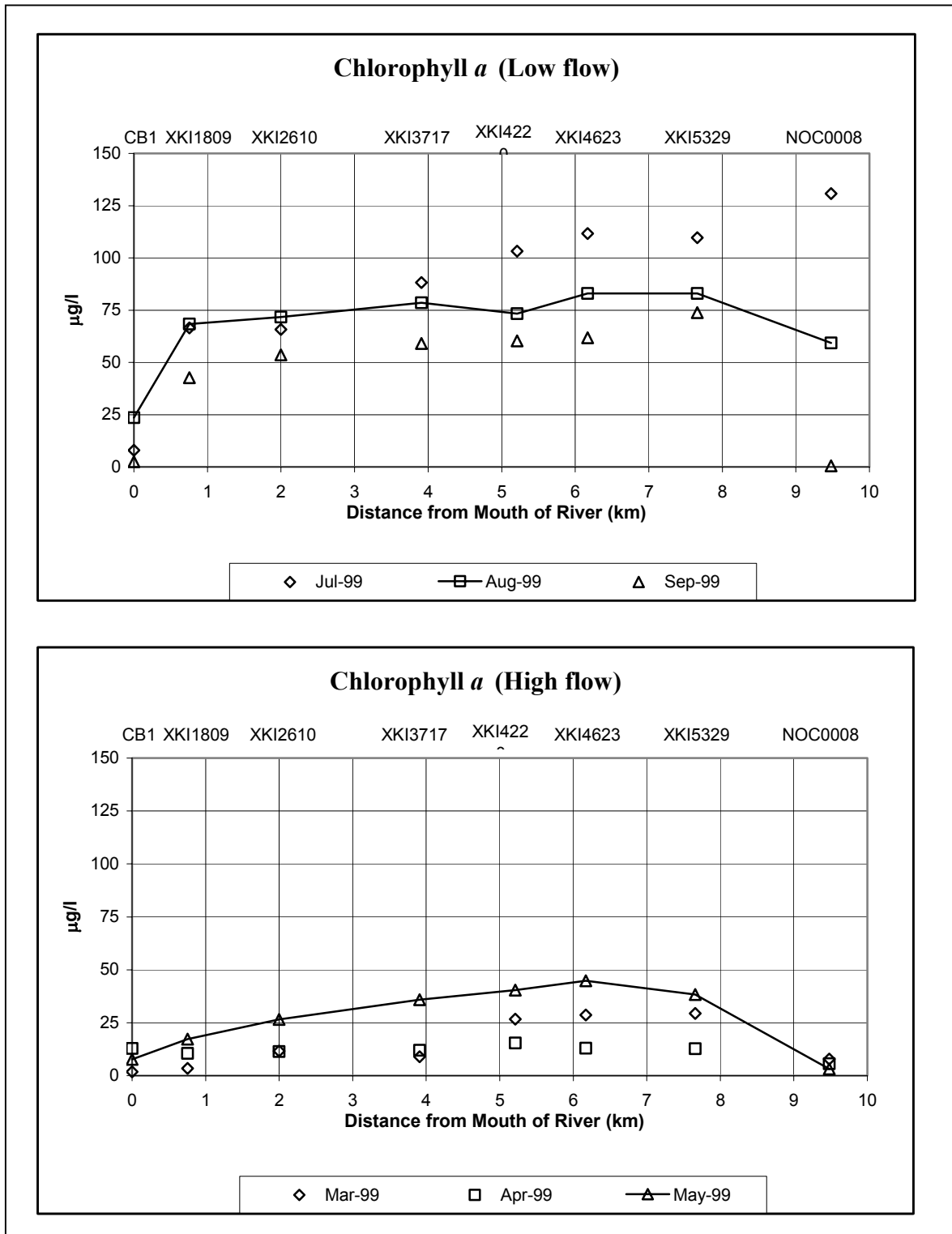

Figure A3: Longitudinal Profile of Chlorophyll *a* data

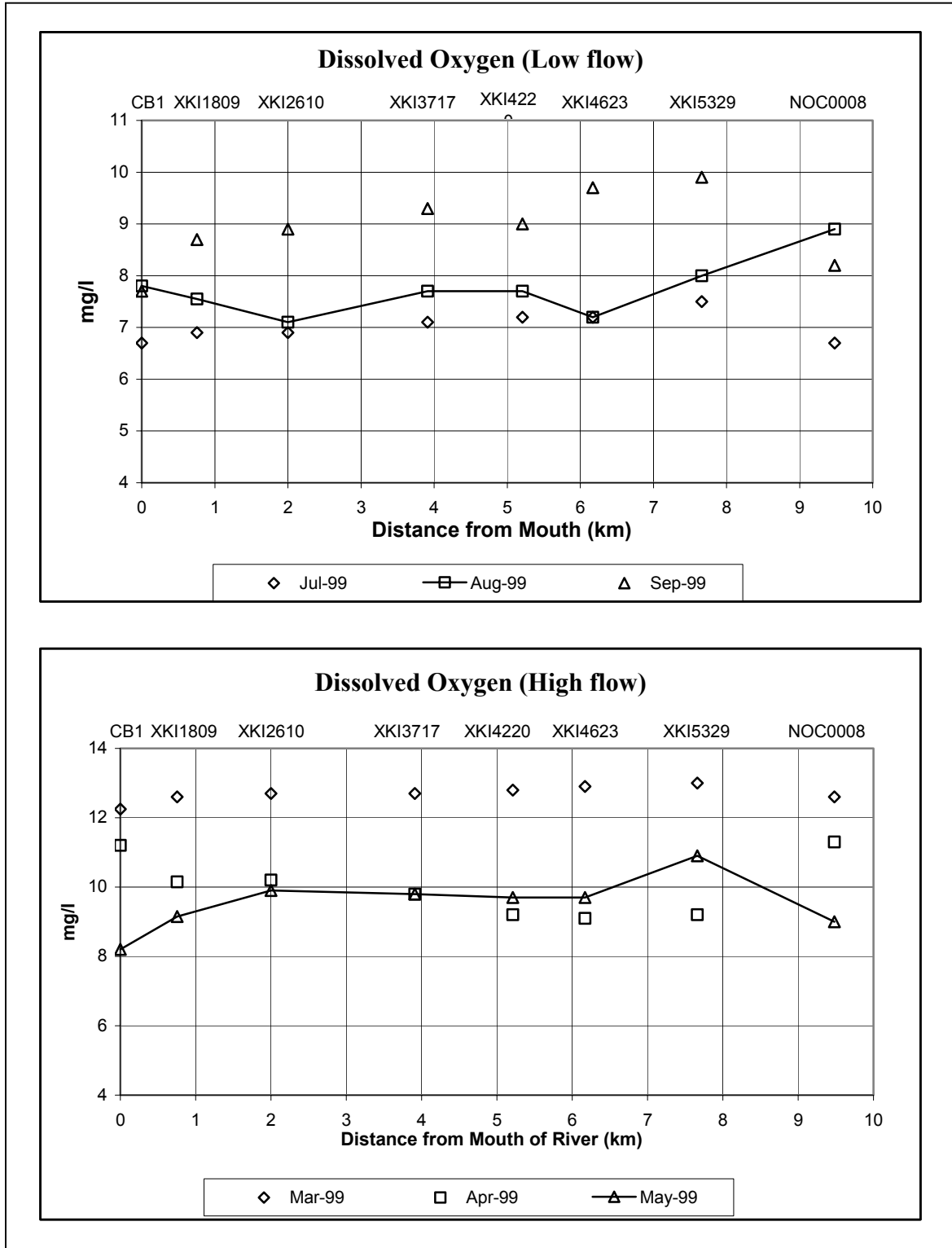

Figure A4: Longitudinal Profile of Dissolved Oxygen Data

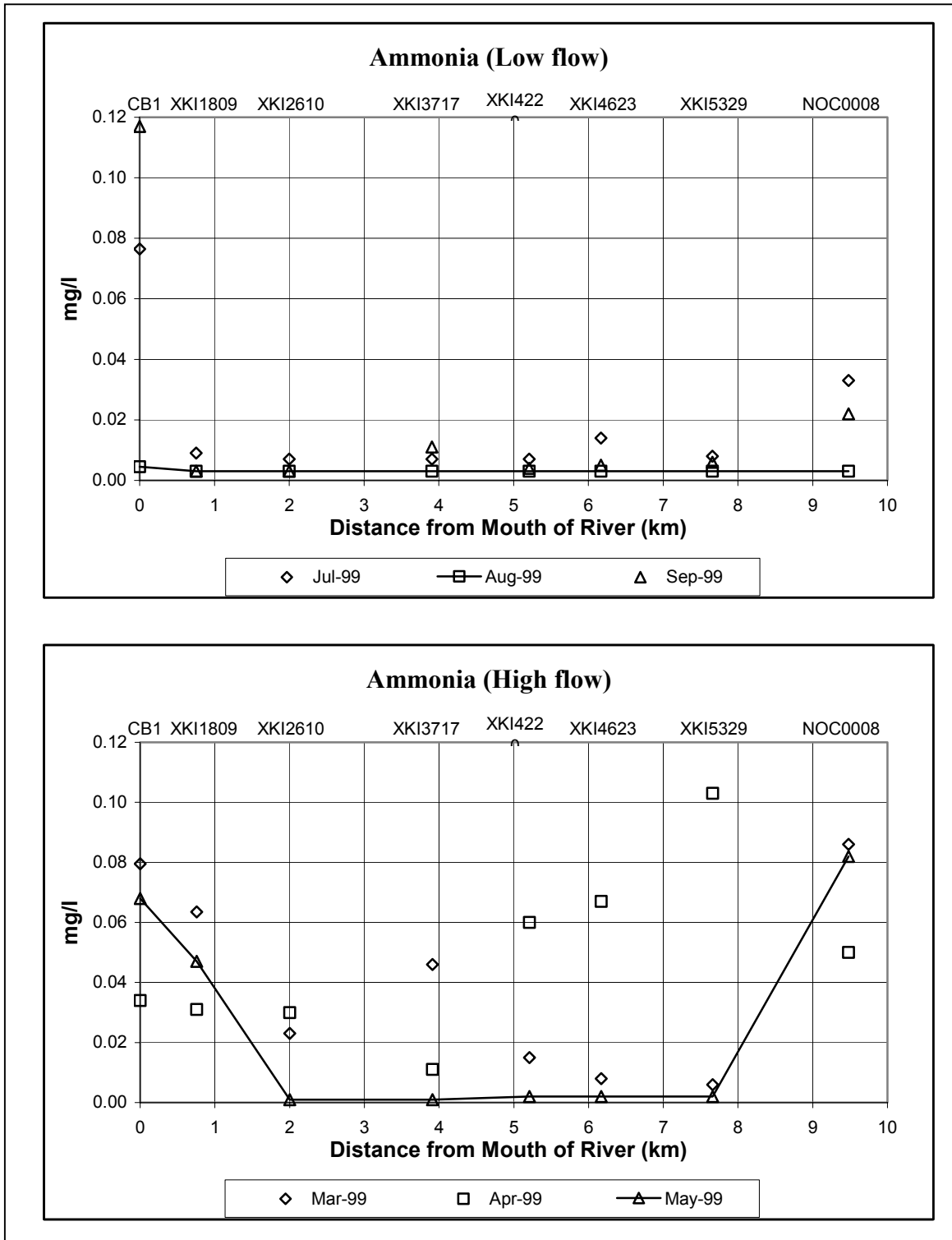
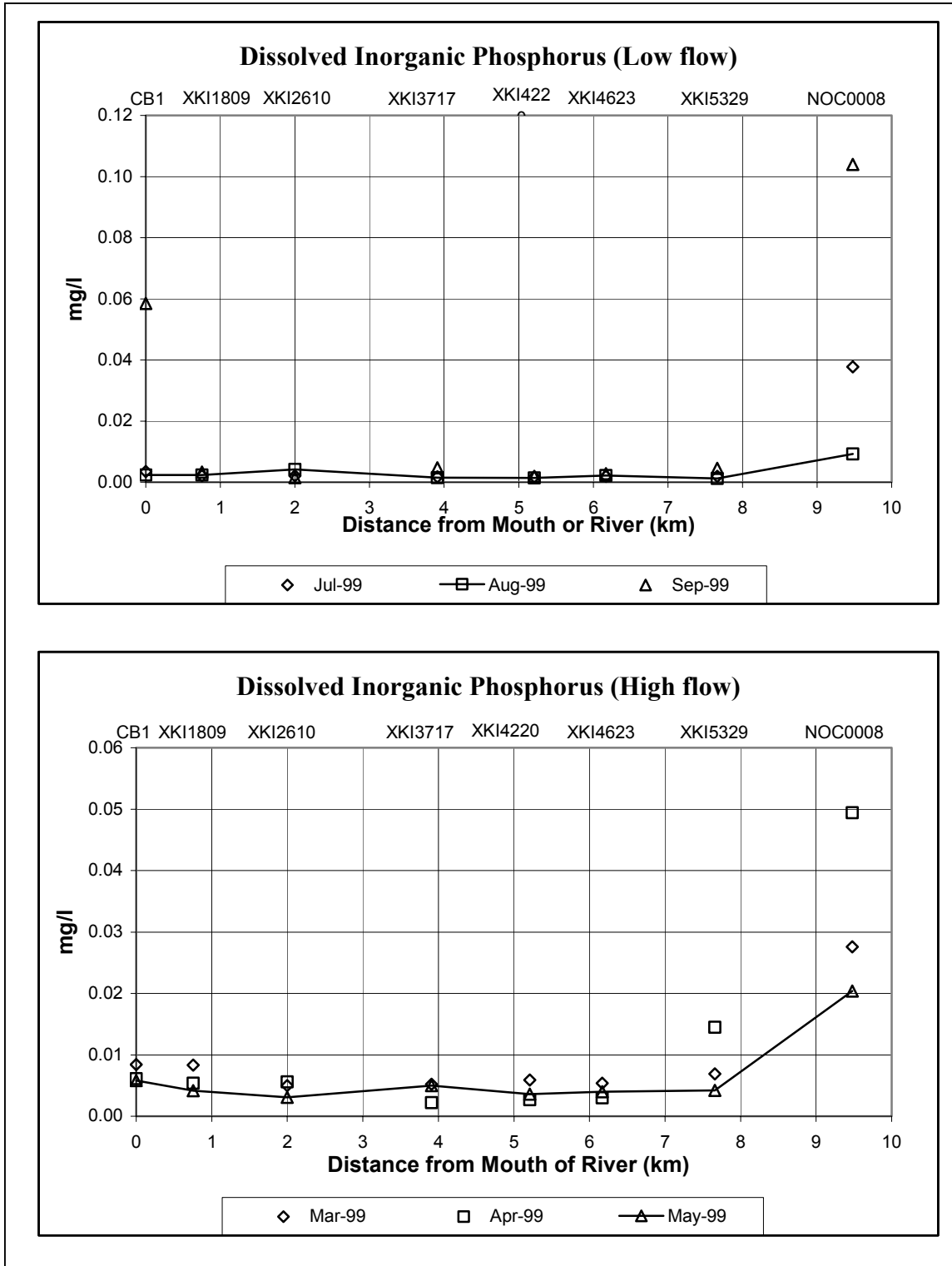
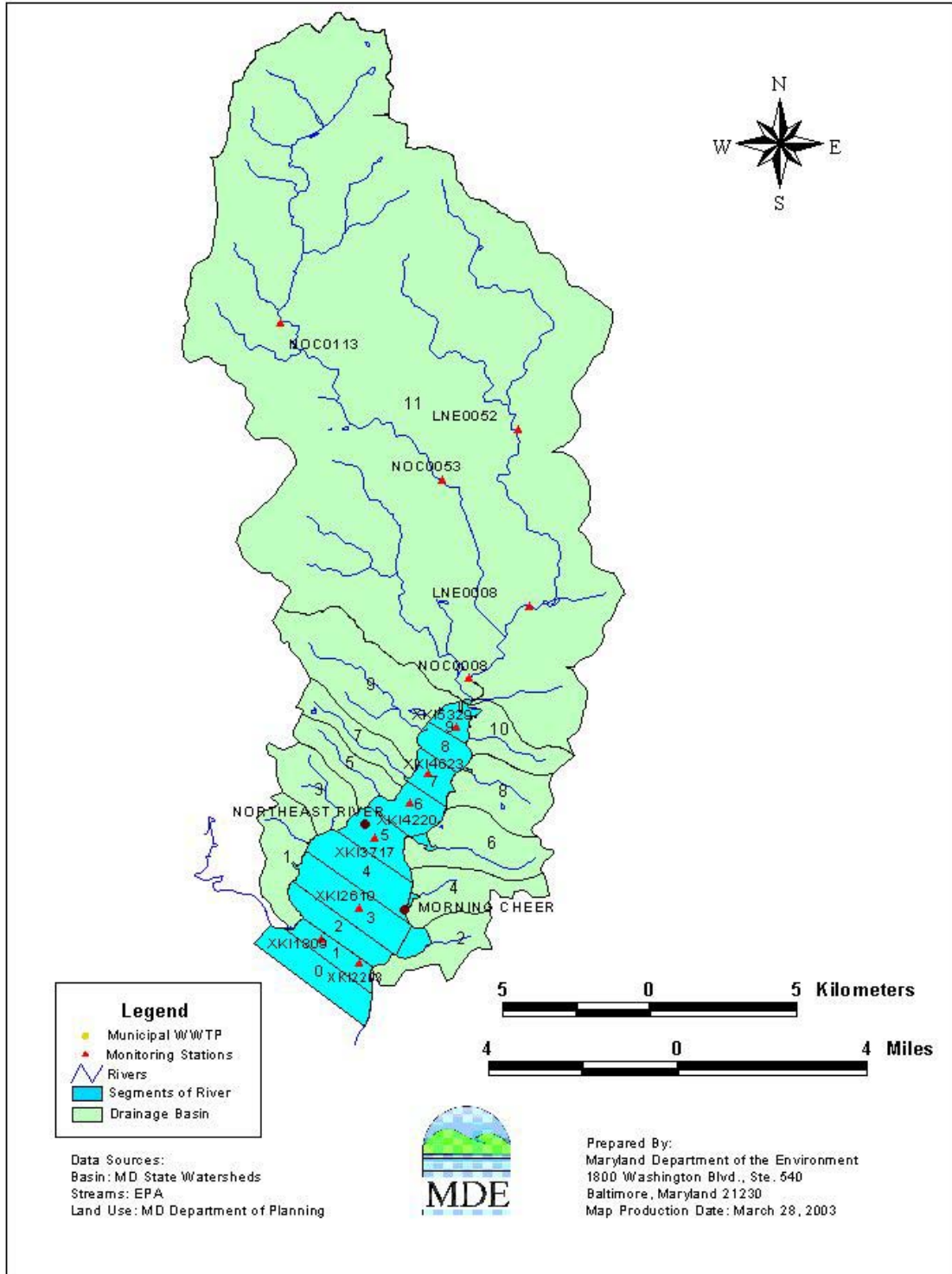

Figure A5: Longitudinal Profile of Ammonia Data



**Figure A6: Longitudinal Profile of Inorganic Phosphorus Data**

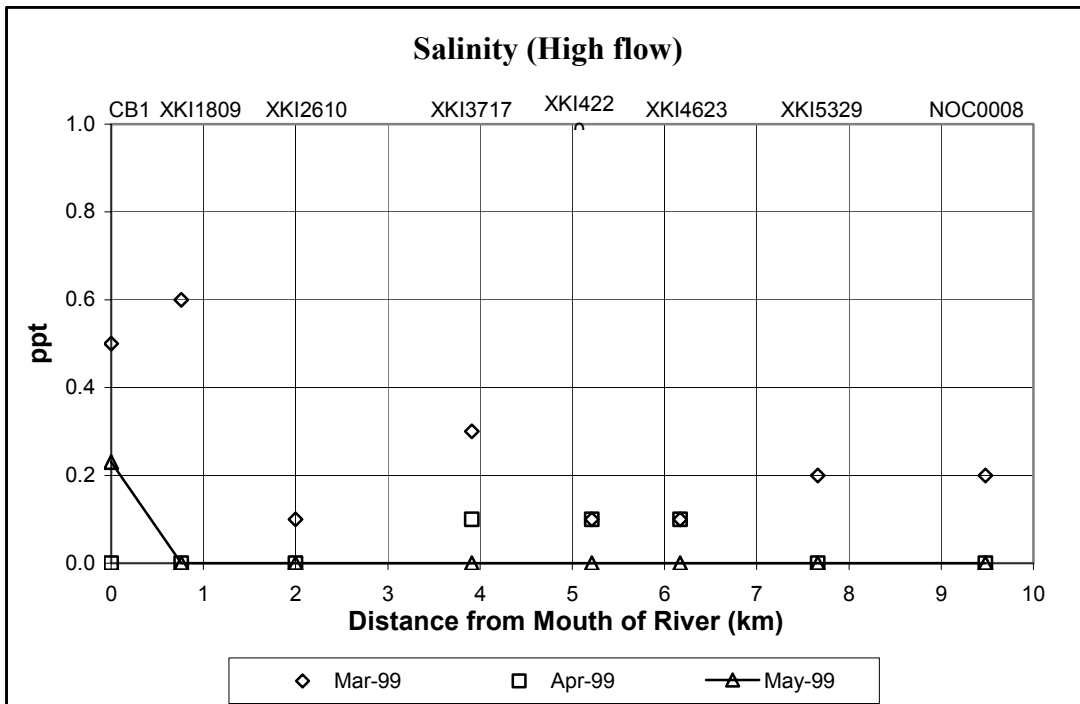
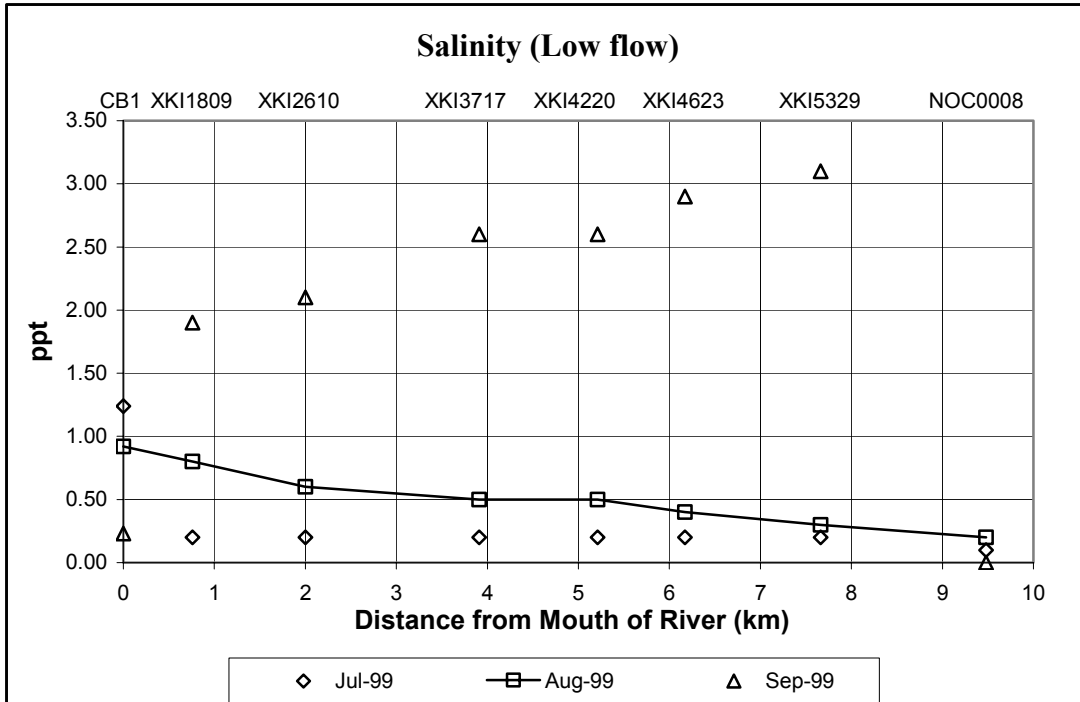



**Figure A7: Model Segmentation**

**Table A2: Volumes, Characteristics Lengths, Interfacial Areas used in the NREM**

Segment	Average Depth of Segment (m)	Surface (m <sup>2</sup> )	Volume (m <sup>3</sup> )	Segment Pair	Interfacial Area (m <sup>2</sup> )	Average Length (m)	Characteristic Length (m)
Bay	2.00	2,894,817	5,786,049	Bay - 0	7,151	820	0
1	2.05	1,526,881	3,135,996	0 - 1	6,313	590	705
2	1.95	1,987,891	3,877,482	1 - 2	4,751	632	611
3	1.90	3,180,052	6,048,332	2 - 3	6,456	914	773
4	2.14	2,915,789	6,237,700	3 - 4	6,876	954	934
5	2.29	1,855,466	4,246,321	4 - 5	5,937	1,026	990
6	2.21	1,762,173	3,899,127	5 - 6	3,146	1,216	1,121
7	2.12	1,122,998	2,385,891	6 - 7	2,752	960	1,088
8	2.37	1,093,858	2,597,249	7 - 8	2,454	756	858
9	2.37	842,611	1,997,800	8 - 9	3,244	962	859
Upstream	1.32	35,515	46,879	9 - Upstream	391	605	1,034



**Figure A8: Longitudinal Profile of Salinity**

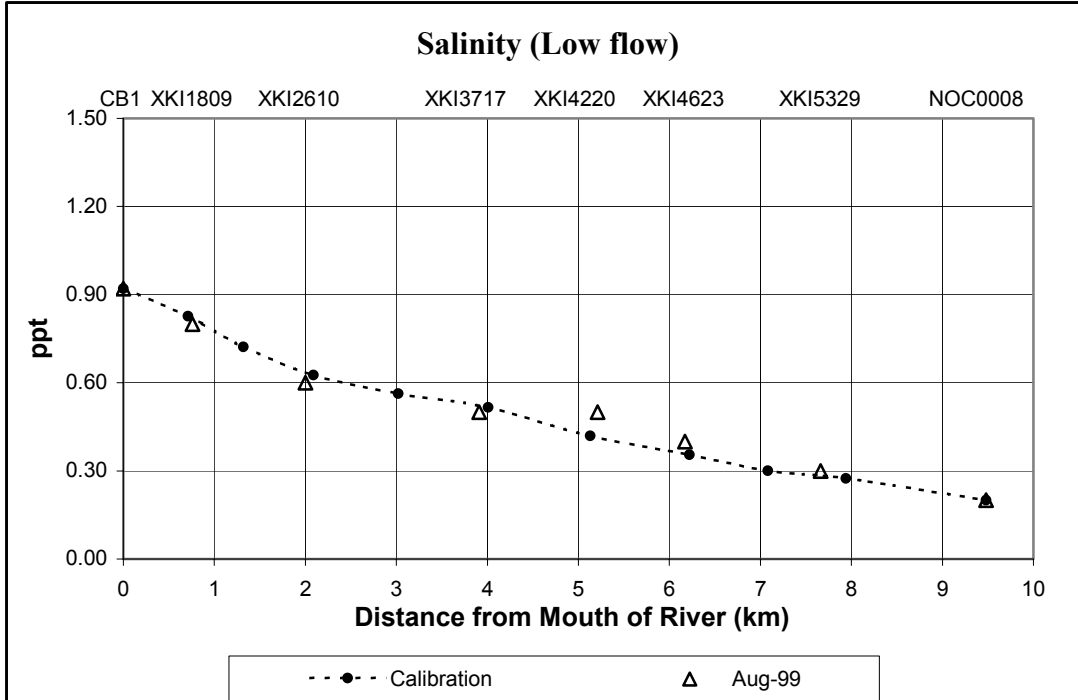

**Figure A9: Results of Calibration of Exchange Coefficients**

**Table A3: Dispersion Coefficients used in the NREM**

Segment Pair	Dispersion Coefficient (m <sup>2</sup> /s)
0 - 1	6.0
1 - 2	6.0
2 - 3	6.0
3 - 4	6.0
4 - 5	6.0
5 - 6	6.0
6 - 7	5.0
7 - 8	5.0
8 - 9	5.0
9 - 0	3.0
3 - 0	5.0
4 - 0	5.0
6 - 0	3.0
8 - 0	3.0

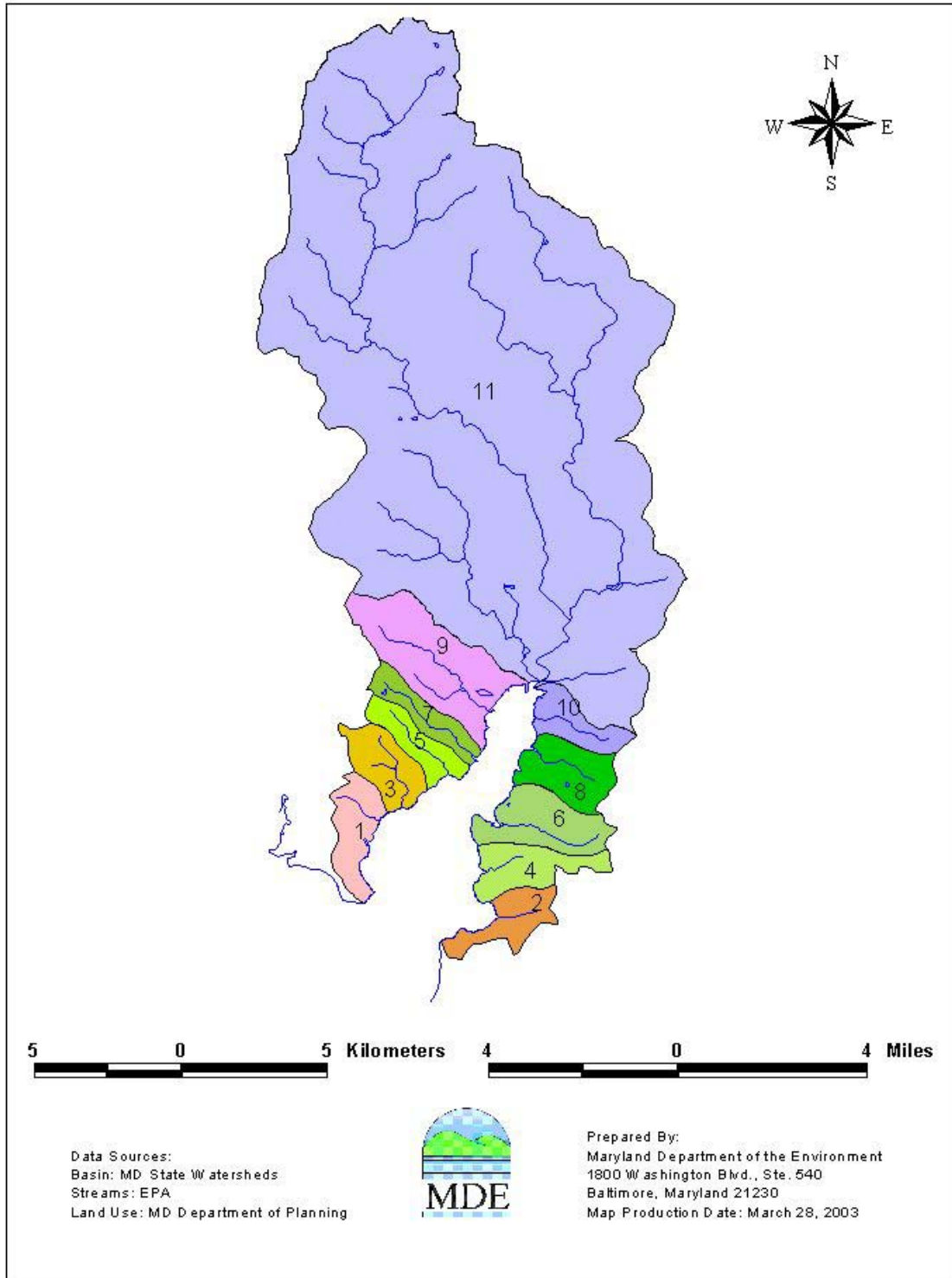

**Figure A10: The Eleven Subwatersheds of the Northeast River Drainage Basin**

**Table A4: Subwatersheds Flow for Low, Critical Low, High, and Annual Conditions**

Subwatershed Number	Low Flow, August 1999 (m <sup>3</sup> /s)	Critical Condition Low Flow, 7Q10 (m <sup>3</sup> /s)	High Flow, May 1999 (m <sup>3</sup> /s)	Average Annual Flow, 1999 (m <sup>3</sup> /s)
1	0.0163	0.0072	0.0266	0.0281
2	0.0140	0.0062	0.0229	0.0242
3	0.0161	0.0071	0.0264	0.0278
4	0.0194	0.0075	0.0278	0.0293
5	0.0125	0.0055	0.0205	0.0216
6	0.0231	0.0102	0.0378	0.0399
7	0.0124	0.0055	0.0203	0.0214
8	0.0191	0.0085	0.0313	0.0331
9	0.0432	0.0191	0.0708	0.0747
10	0.0130	0.0058	0.0213	0.0225
11	0.6801	0.3009	1.1135	1.1754

**Table A5: Flow and Point Sources Loadings for the Calibration of the Model**

Parameter*		Northeast River	Morning Cheer
Flow	High Flow	1,733.7	68.2
	Low Flow	1,854.8	208.2
NH4	High Flow	39.0	0.9
	Low Flow	1.4	2.8
NO23	High Flow	2.3	0.1
	Low Flow	34.3	0.3
PO4	High Flow	0.6	0.2
	Low Flow	1.4	0.5
CBOD	High Flow	28.9	0.2
	Low Flow	8.3	8.6
DO	High Flow	13.7	0.5
	Low Flow	12.4	1.1
ON	High Flow	7.2	0.2
	Low Flow	3.1	0.6
OP	High Flow	0.8	0.03
	Low Flow	0.9	0.1

- Loadings in kg/day
- Flow in m<sup>3</sup>/day

**Table A6: Solar Radiation and Photoperiod used in the Calibration of the Model**

Parameter	Unit	High Flow (Mar-May)	Low Flow (July-September)
<b>Solar Radiation</b>	<i>Langleys</i>	420.0	432.0
<b>Photoperiod</b>	<i>Fraction of a day</i>	0.54	0.56

**Table A7: Environmental Parameters for the Calibration of the Model**

Segment Number	Ke (m <sup>-1</sup> )		T (°C)		Salinity (gm/l)		SOD (g O <sub>2</sub> /m <sup>2</sup> day)		FNH <sub>4</sub> (mg NH <sub>4</sub> N/m <sup>2</sup> day)		FPO <sub>4</sub> (mg PO <sub>4</sub> <sup>-</sup> P/m <sup>2</sup> day)	
	High flow	Low flow	High flow	Low flow	High flow	Low flow	High flow	Low flow	High flow	Low flow	High flow	Low flow
1	1.5	2.8	19.9	28.5	0.00	0.83	0.5	1.0	1.0	15.0	1.0	1.0
2	1.5	2.8	19.9	28.5	0.00	0.73	0.5	1.0	1.0	15.0	1.0	1.0
3	4.8	4.8	19.9	27.6	0.00	0.64	0.5	1.0	1.0	15.0	1.0	1.0
4	4.8	4.8	19.9	27.6	0.00	0.58	0.5	1.0	1.0	15.0	1.0	1.0
5	4.8	4.8	19.9	27.6	0.00	0.53	0.5	1.0	1.0	15.0	1.0	1.0
6	4.8	4.8	19.9	27.6	0.00	0.44	0.5	1.0	1.0	15.0	1.0	1.0
7	4.8	4.8	19.9	28.0	0.00	0.38	0.5	1.0	1.0	15.0	1.0	1.0
8	4.8	4.8	19.9	28.0	0.00	0.33	0.5	1.0	1.0	15.0	1.0	1.0
9	9.8	4.8	15.9	28.7	0.00	0.31	0.5	1.0	1.0	15.0	1.0	1.0

**Table A8: EUTRO5 Kinetic Coefficients**

Constant	Code	Value
Nitrification rate	K12C	0.12 <i>day</i> <sup>-1</sup> at 20° C
temperature coefficient	K12T	1.08
Denitrification rate	K20C	0.07 <i>day</i> <sup>-1</sup> at 20° C
temperature coefficient	K20T	1.08
Saturated growth rate of phytoplankton	K1C	2.0 <i>day</i> <sup>-1</sup> at 20° C
temperature coefficient	K1T	1.08
Endogenous respiration rate	K1RC	0.025 <i>day</i> <sup>-1</sup> at 20° C
temperature coefficient	K1RT	1.045
Nonpredatory phytoplankton death rate	K1D	0.075 <i>day</i> <sup>-1</sup>
Phytoplankton Stoichiometry		
oxygen-to-carbon ratio	ORCB	2.67 <i>mg O<sub>2</sub>/ mg C</i>
carbon-to-chlorophyll ratio	CCHL	35
nitrogen-to-carbon ratio	NCRB	0.20 <i>mg N/mg C</i>
phosphorus-to-carbon ratio	PCRB	0.020 <i>mg PO<sub>4</sub>-P/ mg C</i>
Half-saturation constants for phytoplankton growth		
nitrogen	KMNG1	0.010 <i>mg N /L</i>
phosphorus	KMPG1	0.001 <i>mg P /L</i>
Fraction of dead phytoplankton recycled to organic		
nitrogen	FON	1.0
phosphorus	FOP	1.0
Light Formulation Switch	LGHTS	1 = Di Toro option
Saturation light intensity for phytoplankton	IS1	450. <i>Ly/day</i>
BOD deoxygenation rate	KDC	0.10 <i>day</i> <sup>-1</sup> at 20° C
temperature coefficient	KDT	1.05
Mineralization rate of dissolved organic nitrogen	K71C	0.027 <i>day</i> <sup>-1</sup>
temperature coefficient	K71T	1.08
Mineralization rate of dissolved organic phosphorus	K58C	0.15 <i>day</i> <sup>-1</sup>
temperature coefficient	K58T	1.08
Phytoplankton settlig velocity		1.0E-07 m/s
Organics settlig velocity		1.0E-07 m/s



**Table A9: Contributing Watersheds to Each Model Segment, and Flows for the Segments**

Segment Number	Contributing Subwatersheds	Low Flow (m <sup>3</sup> /s)	Baseline Low Flow (m <sup>3</sup> /s)	High Flow (m <sup>3</sup> /s)	Average Flow (m <sup>3</sup> /s)
3	2	0.0140	0.0062	0.0229	0.0242
4	1+3+4+Morning Cheer WWTP flow	0.0518	0.0242	0.0816	0.0877
5	Northeast River WTPP flow	0.0215	0.0876	0.0201	0.0876
6	5+6	0.0356	0.0158	0.0583	0.0615
7	7	0.0124	0.0055	0.0203	0.0214
8	8+9	0.0624	0.0276	0.1021	0.1078
9	10+11	0.6931	0.3067	1.1348	1.1977

**Table A10: Nonpoint Source Concentrations for the Low Flow Calibration of the Model and Low Flow Baseline Scenario**

Segment Number	NH4 mg/l	NO <sub>23</sub> mg/l	PO <sub>4</sub> mg/l	CHL <i>a</i> µg/l	CBOD mg/l	DO mg/l	ON mg/l	OP mg/l
3	0.0693	1.3767	0.0465	1.50	2.67	6.60	0.3053	0.0256
4	0.0693	1.3767	0.0465	1.50	2.67	6.60	0.3053	0.0256
5	-	-	-	-	-	-	-	-
6	0.0693	1.3767	0.0465	1.50	2.67	6.60	0.3053	0.0256
7	0.0693	1.3767	0.0465	1.50	2.67	6.60	0.3053	0.0256
8	0.0693	1.3767	0.0465	1.50	2.67	6.60	0.3053	0.0256
9	0.0030	0.0098	0.0092	59.30	12.67	8.90	1.5020	0.0899

**Table A11: Nonpoint Source Concentrations for the High Flow Calibration of the Model**

Segment Number	NH4 mg/l	NO <sub>23</sub> mg/l	PO <sub>4</sub> mg/l	CHL <i>a</i> µg/l	CBOD mg/l	DO mg/l	ON mg/l	OP mg/l
3	0.0523	0.5667	0.0221	3.33	2.95	9.43	0.2967	0.0256
4	0.0523	0.5667	0.0221	3.33	2.95	9.43	0.2967	0.0256
5	-	-	-	-	-	-	-	-
6	0.0523	0.5667	0.0221	3.33	2.95	9.43	0.2967	0.0256
7	0.0523	0.5667	0.0221	3.33	2.95	9.43	0.2967	0.0256
8	0.0523	0.5667	0.0221	3.33	2.95	9.43	0.2967	0.0256
9	0.0820	1.2400	0.0204	3.20	2.83	9.00	0.4120	0.0899

### Low Flow Calibration

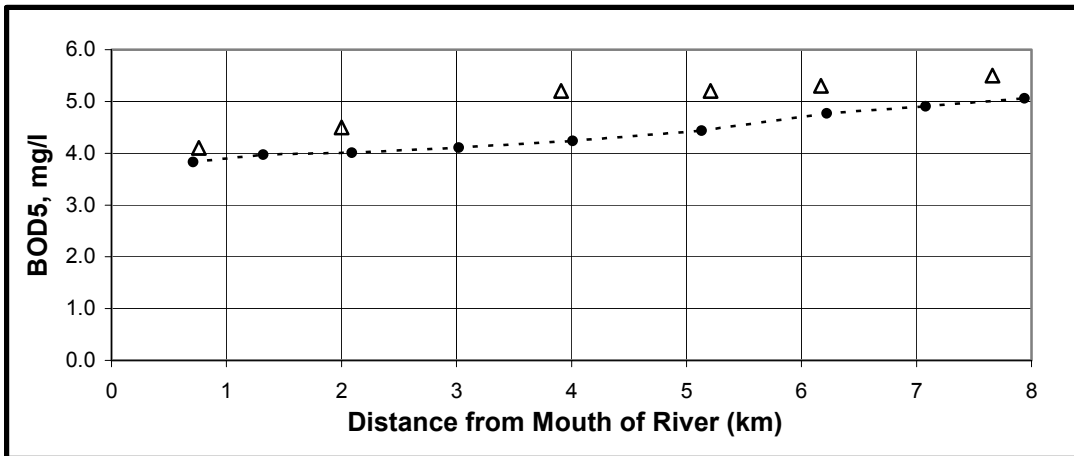

Figure A11: BOD vs. River Kilometer for the Calibration of the Model

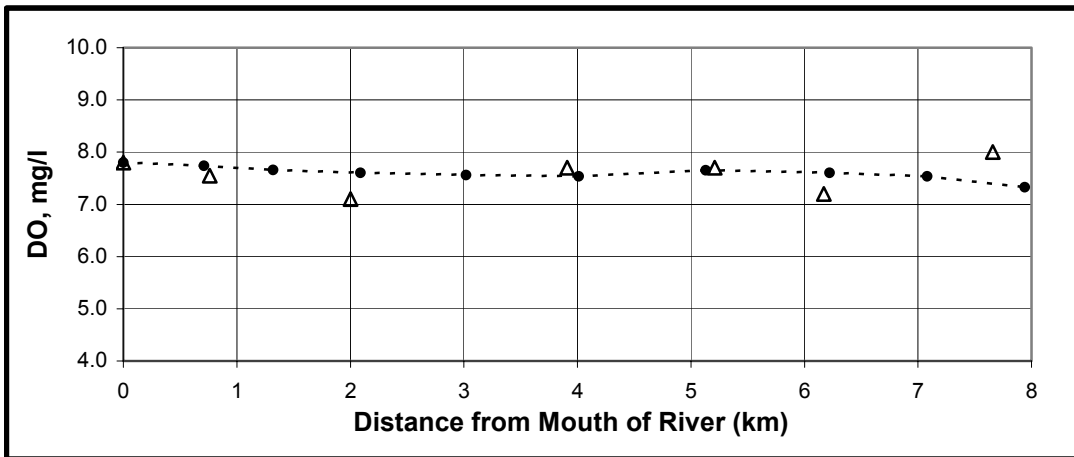

Figure A12: Dissolved Oxygen vs. River Kilometer for the Calibration of the Model

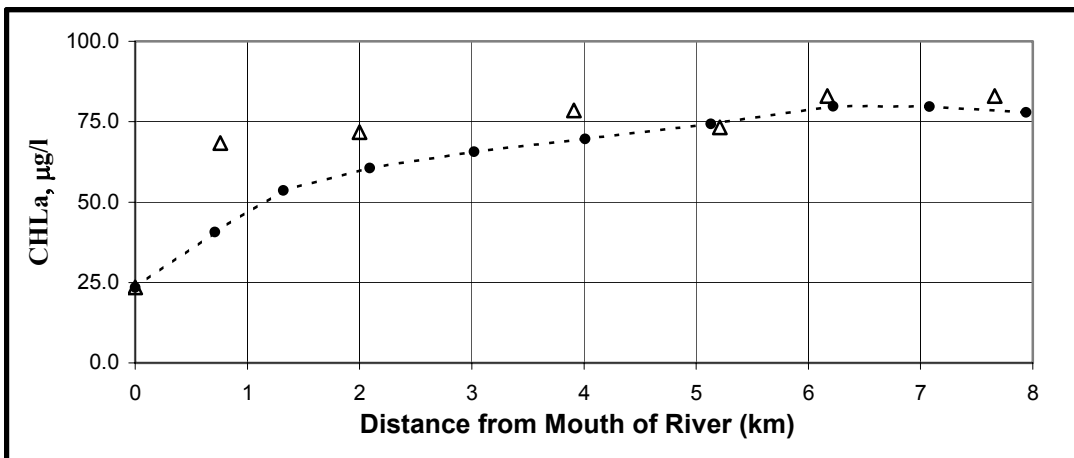

Figure A13: Chlorophyll a vs. River Kilometer for the Calibration of the Model

Δ - Monitoring data    - - - • - - - Calibration

### Low Flow Calibration

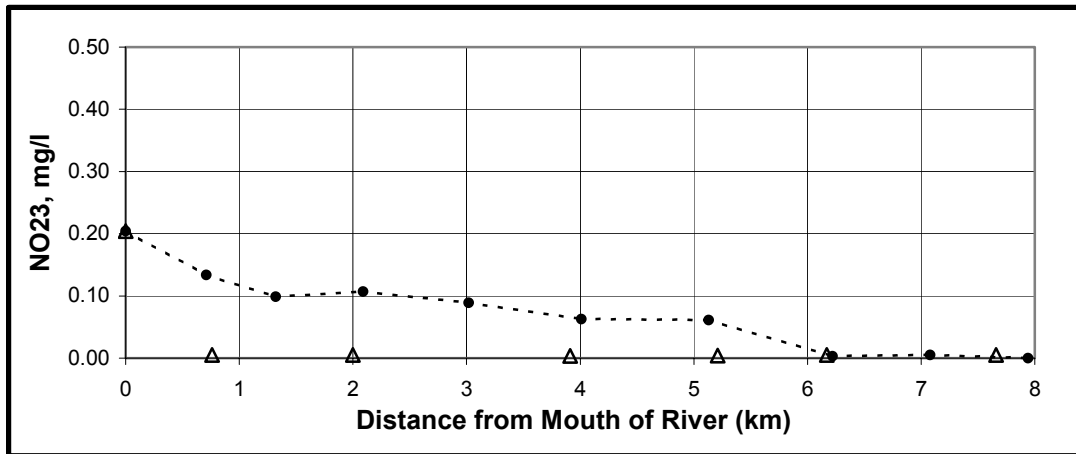

Figure A14: Nitrate (plus Nitrite) vs. River Kilometer for the Calibration of the Model

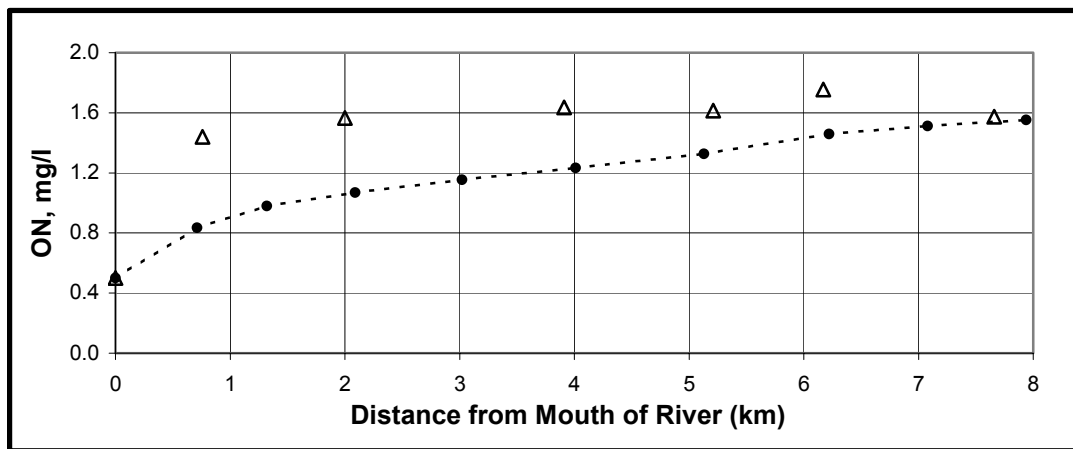

Figure A15: Organic Nitrogen vs. River Kilometer for the Calibration of the Model

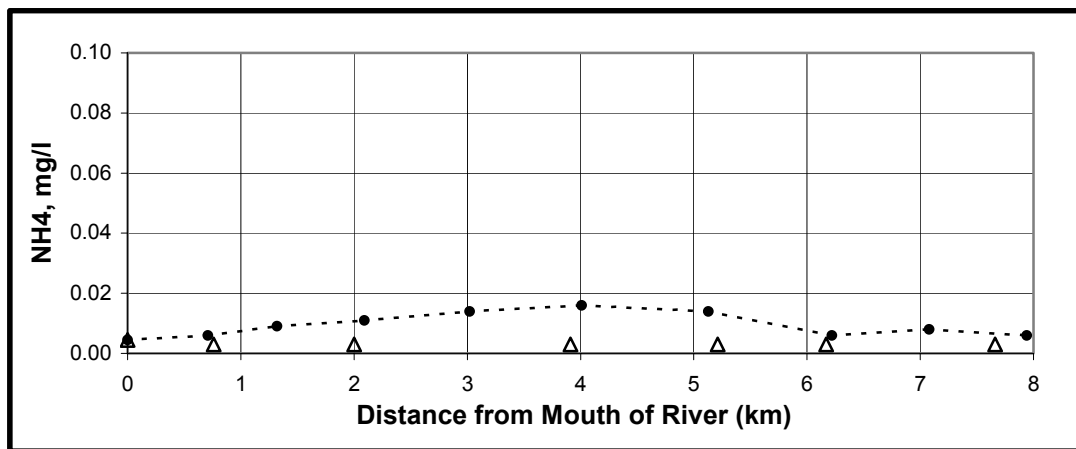

Figure A16: Ammonia vs. River Kilometer for the Calibration of the Model

Δ - Monitoring data    ···· Calibration

### Low Flow Calibration

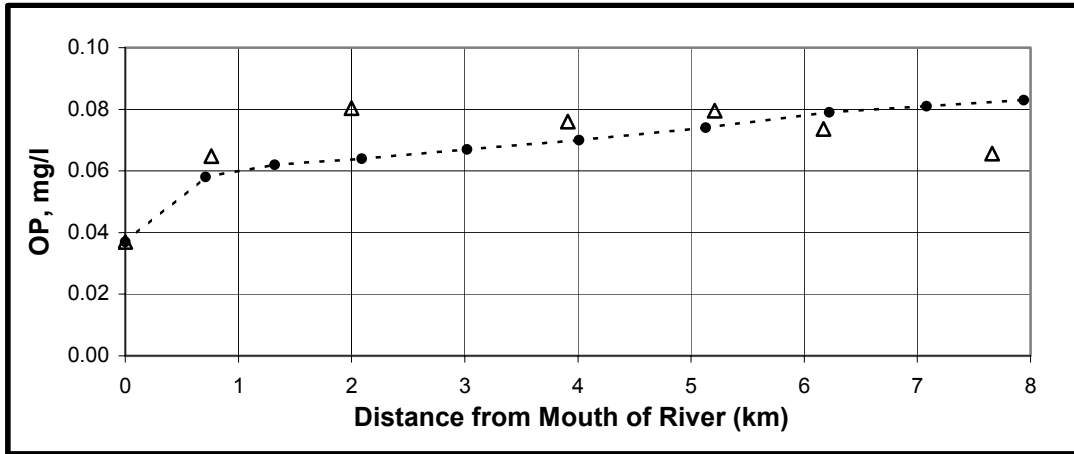

Figure A17: Organic Phosphorus vs. River Kilometer for the Calibration of the Model

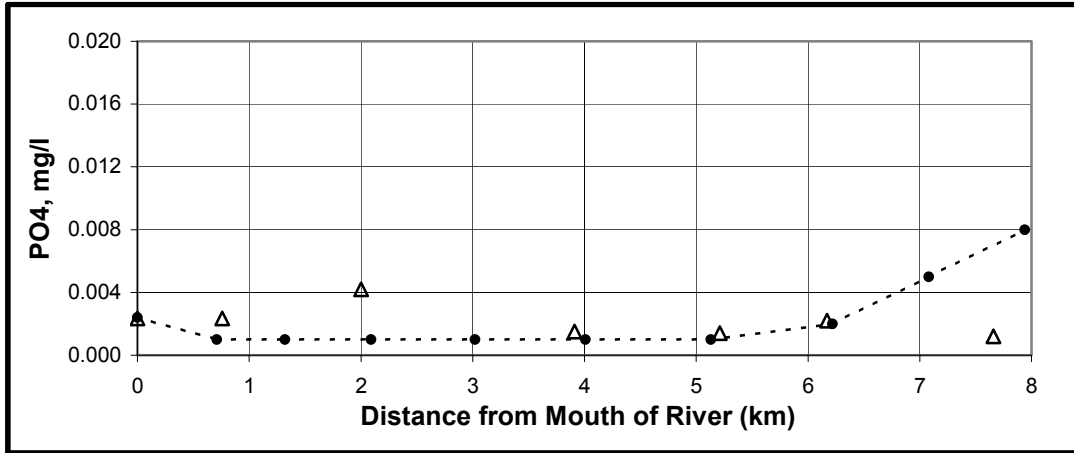

Figure A18: Ortho-Phosphate vs. River Kilometer for the Calibration of the Model

△ - Monitoring data    - - ● - Calibration

### High Flow Calibration

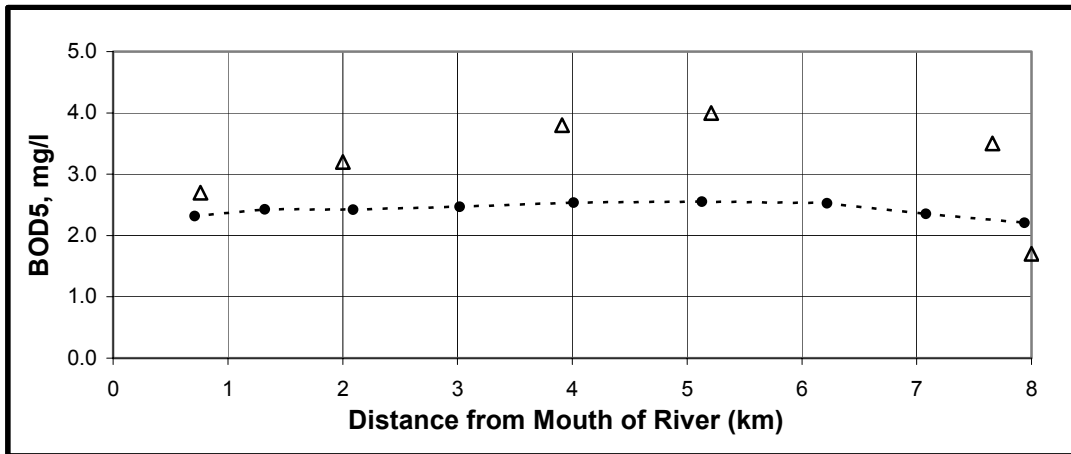

Figure A19: BOD vs. River Kilometer for the Calibration of the Model

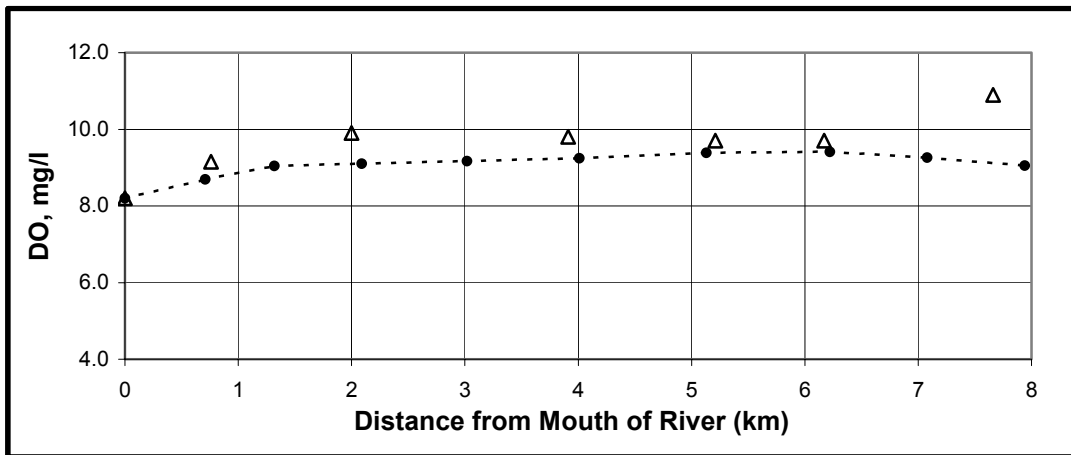

Figure A20: Dissolved Oxygen vs. River Kilometer for the Calibration of the Model

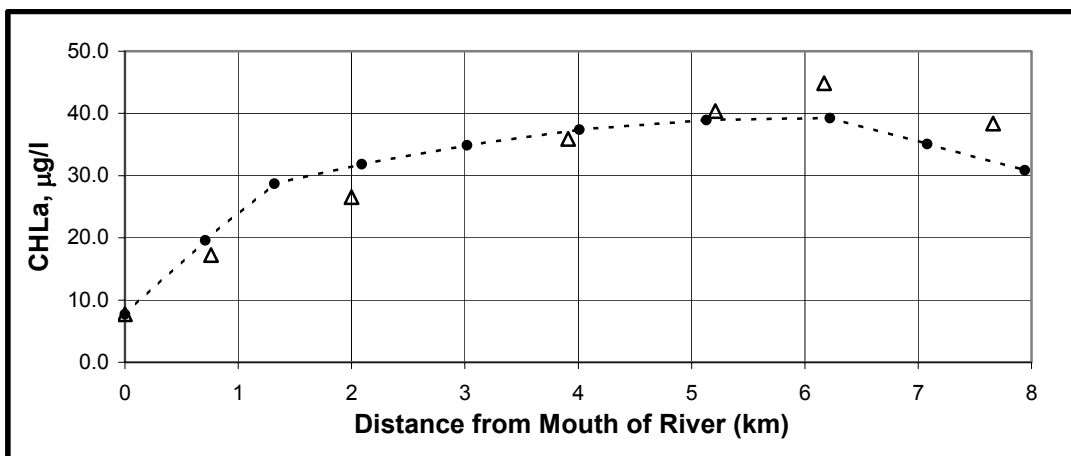

Figure A21: Chlorophyll a vs. River Kilometer for the Calibration of the Model

Δ - Monitoring data    - - - Calibration

### High Flow Calibration

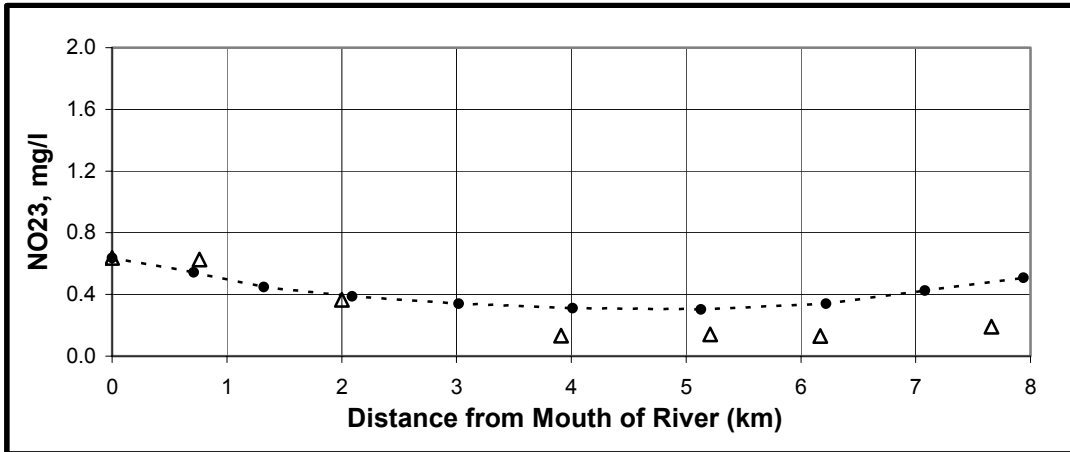

Figure A22: Nitrate & Nitrite vs. River Kilometer for the Calibration of the Model

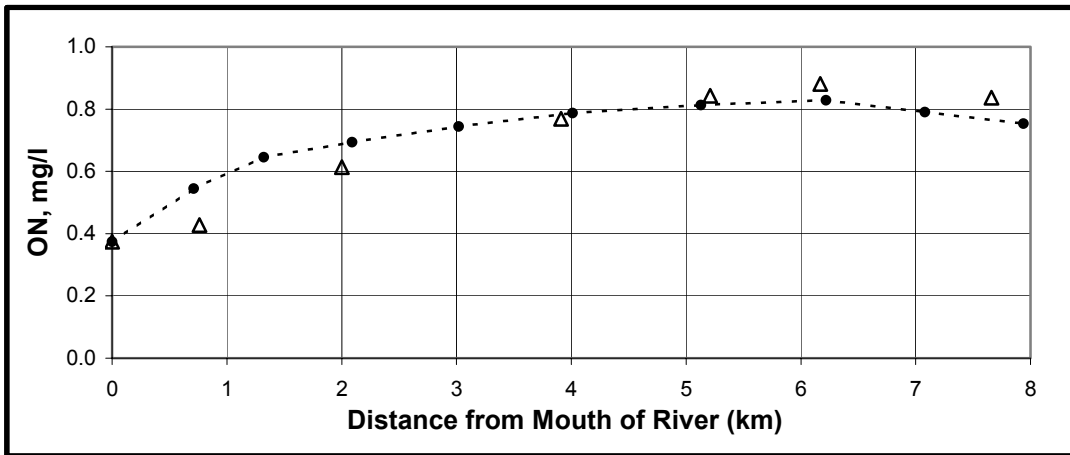

Figure A23: Organic Nitrogen vs. River Kilometer for the Calibration of the Model

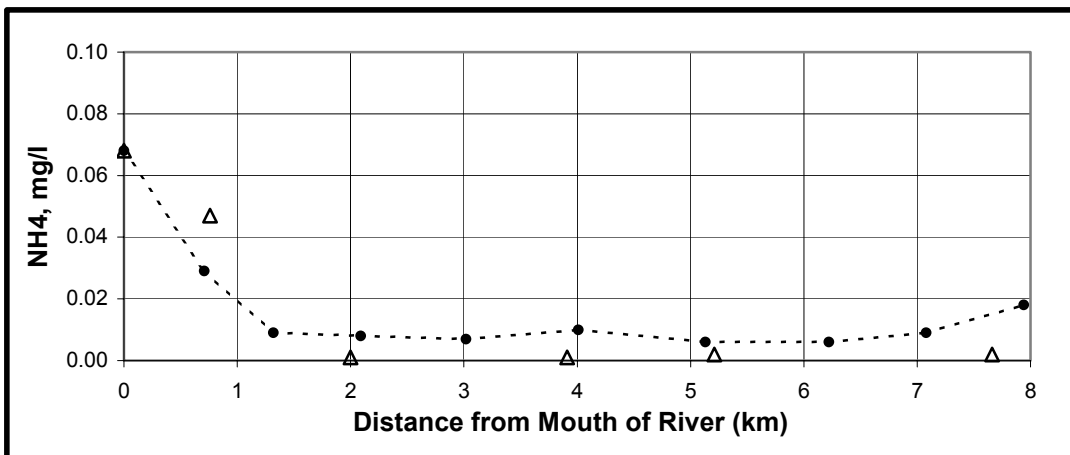

Figure A24: Ammonia vs. River Kilometer for the Calibration of the Model

Δ - Monitoring data    -●- Calibration

### High Flow Calibration

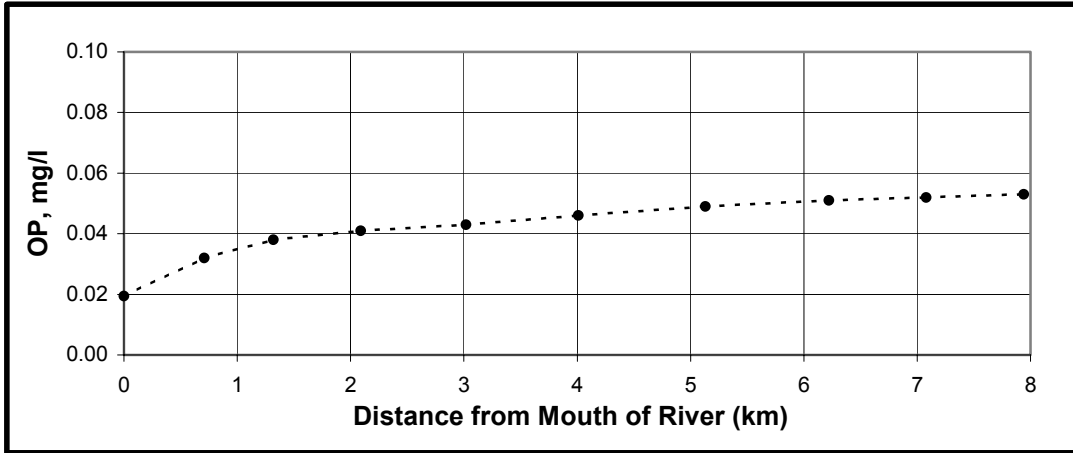

Figure A25: Organic Phosphorus vs. River Kilometer for the Calibration of the Model

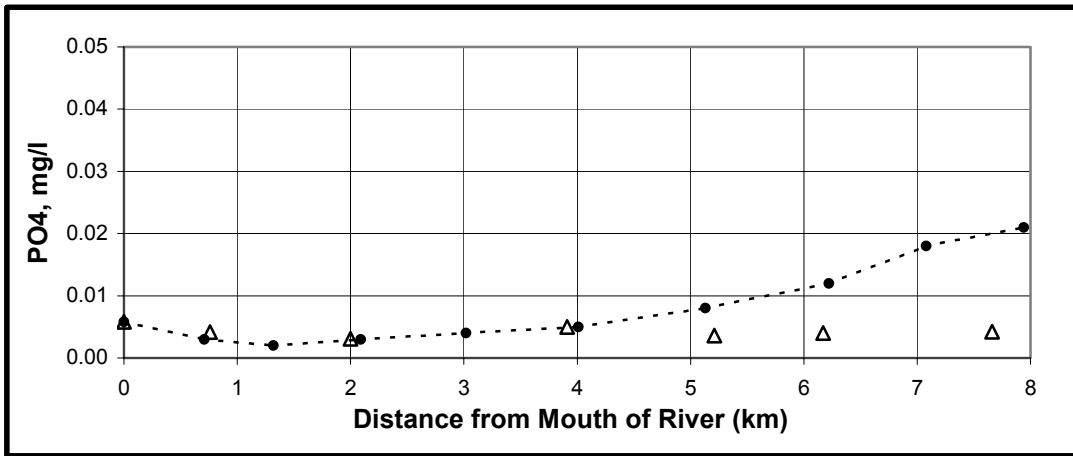

Figure A26: Ortho-Phosphate vs. River Kilometer for the Calibration of the Model

Δ - Monitoring data    - - - Calibration

**Table A12: Flow and Point Sources Loadings used in the Baseline Low Flow Condition Scenario, Baseline Average Annual Scenario and TMDL Scenarios**

Parameter*	Northeast River			Morning Cheer
	Baseline Low Flow and Average Flow	Low flow TMDL	Average Flow TMDL	Baselines and TMDLs
<b>Flow</b>	7570.82	7570.82	7570.82	208.20
<b>NH<sub>4</sub></b>	48.98	19.21	19.21	2.81
<b>NO<sub>2-3</sub></b>	81.84	32.10	32.10	0.32
<b>PO<sub>4</sub></b>	8.33	4.33	4.33	0.52
<b>CBOD</b>	378.61	378.61	378.61	10.42
<b>DO</b>	57.79	57.79	57.79	1.43
<b>ON</b>	23.60	9.25	9.25	0.62
<b>OP</b>	6.81	3.24	3.24	0.10

All loadings in kg/day. Flow in m<sup>3</sup>/day

**Table A13: Nonpoint Source Concentrations for the Average Annual Flow Condition**

Segment Number	NH <sub>4</sub> mg/l	NO <sub>23</sub> mg/l	PO <sub>4</sub> mg/l	CHL <i>a</i> µg/l	CBOD mg/l	DO mg/l	ON mg/l	OP mg/l
3	0.0523	1.8305	0.0420	10.11	4.82	9.31	0.5590	0.0324
4	0.0523	1.8305	0.0420	10.11	4.82	9.31	0.5590	0.0324
6	0.0523	1.8305	0.0420	10.11	4.82	9.31	0.5590	0.0324
7	0.0523	1.8305	0.0420	10.11	4.82	9.31	0.5590	0.0324
8	0.0523	1.8305	0.0420	10.11	4.82	9.31	0.5590	0.0324
9	0.0460	1.1395	0.0414	34.54	7.75	9.45	0.8879	0.0671



### Baseline Low Flow Condition Scenario (BLF)

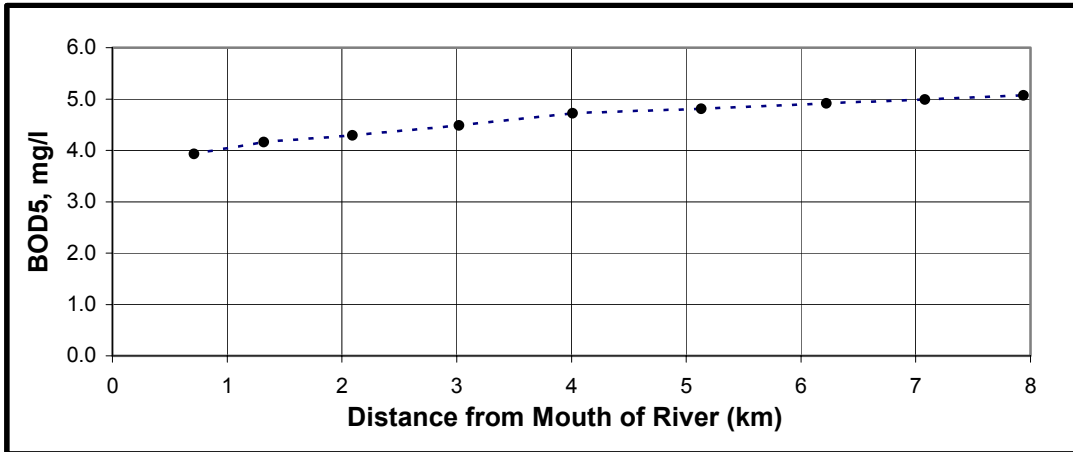

Figure A27: BOD vs. River Kilometer for the BLF

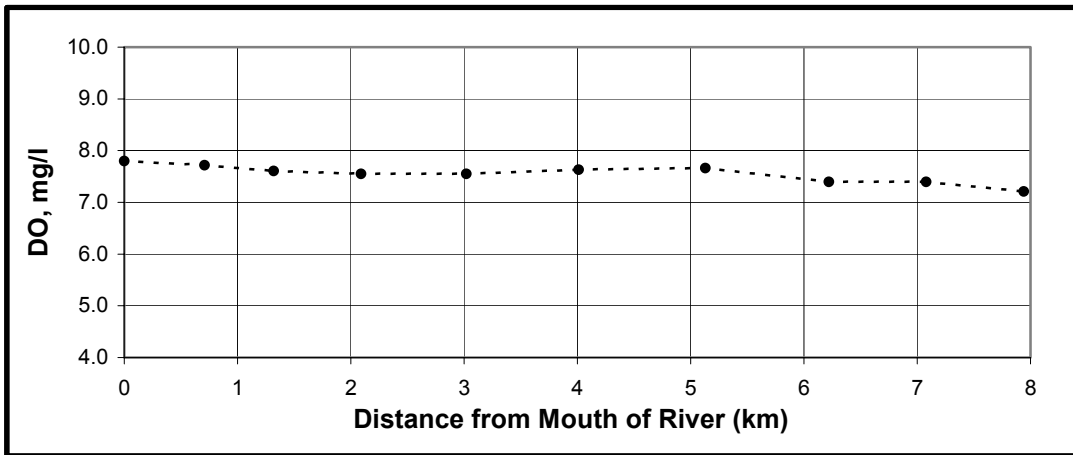

Figure A28: Dissolved Oxygen vs. River Kilometer for the BLF

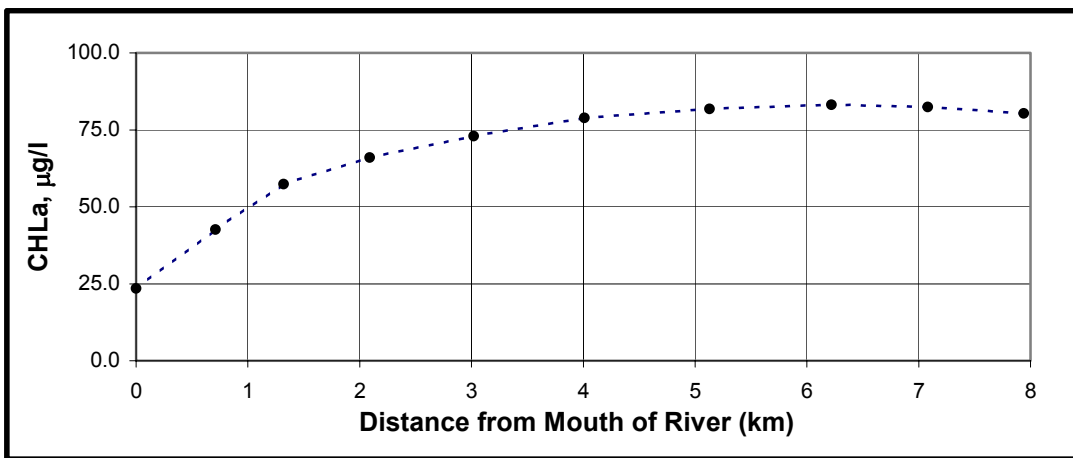
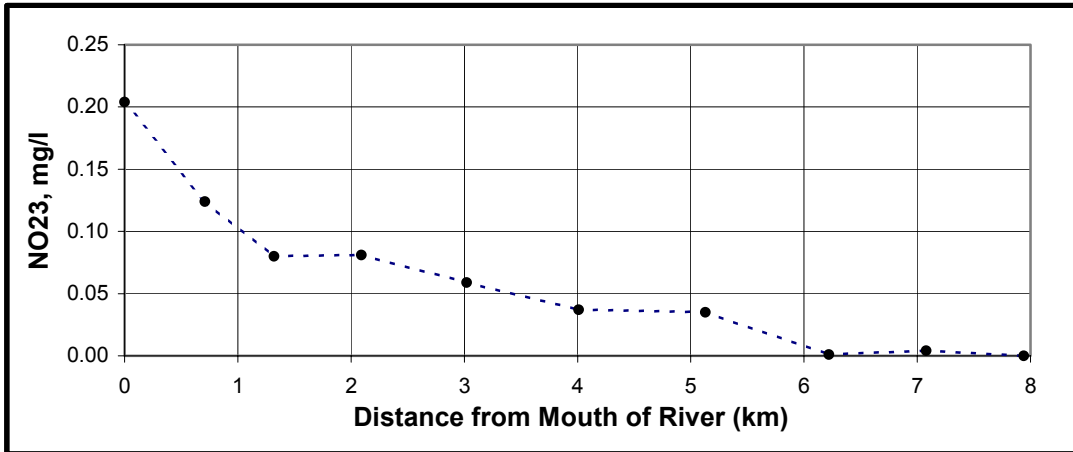
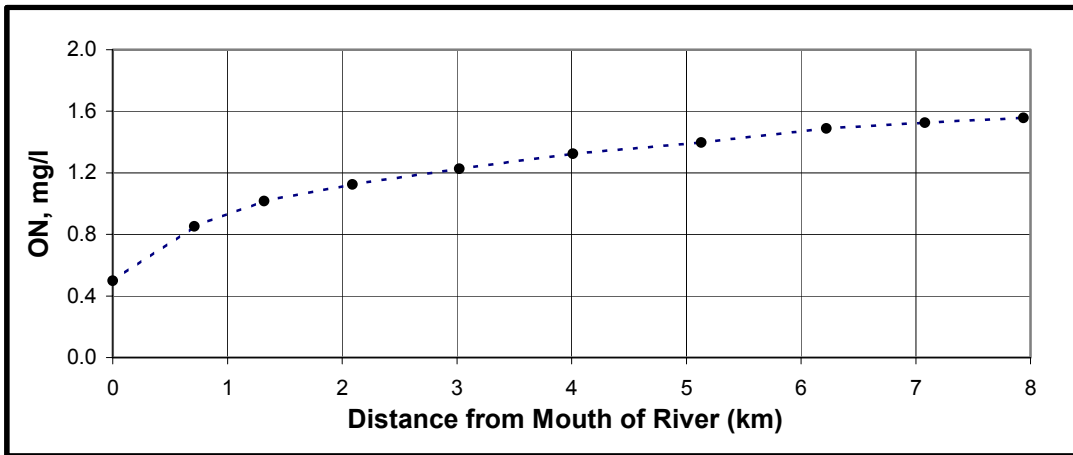

Figure A29: Chlorophyll a vs. River Kilometer for the BLF

**Baseline Low Flow Condition Scenario (BLF)**



**Figure A30: Nitrate (plus Nitrite) vs. River Kilometer for the BLF**



**Figure A31: Organic Nitrogen vs. River Kilometer for the BLF**

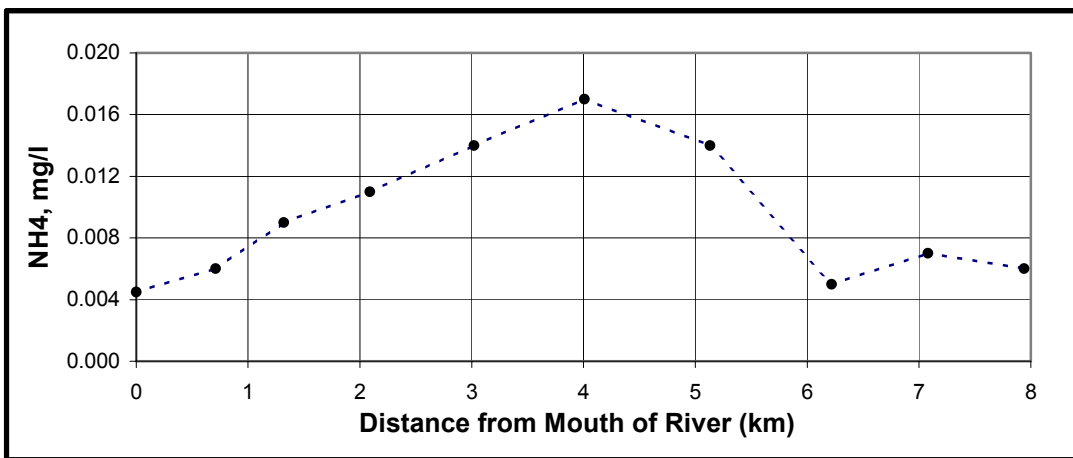

**Figure A32: Ammonia vs. River Kilometer for the BLF**

### Baseline Low Flow Condition Scenario (BLF)

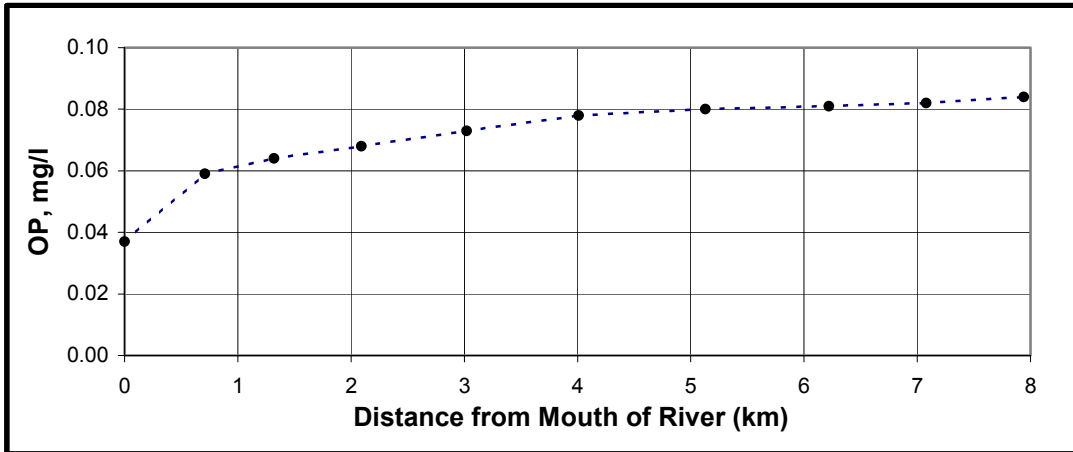

Figure A33: Organic Phosphorus vs. River Kilometer for the BLF

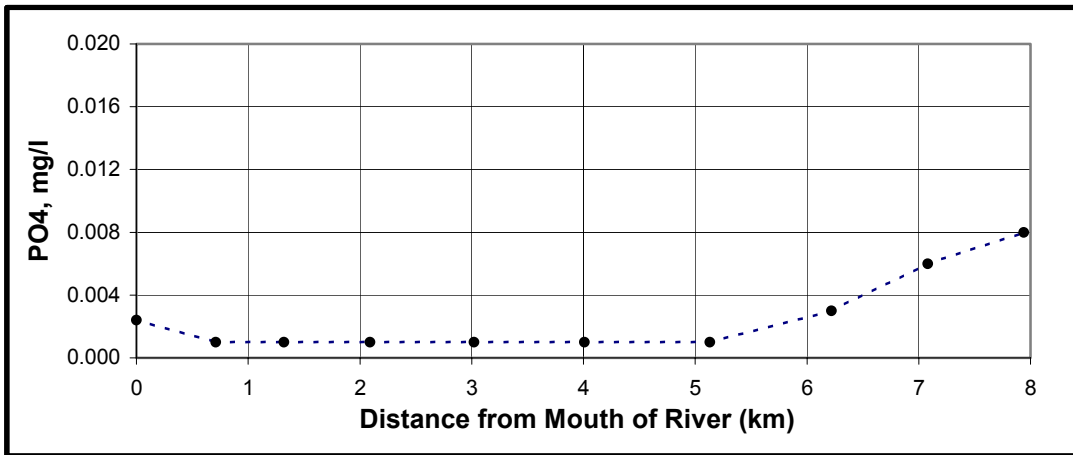
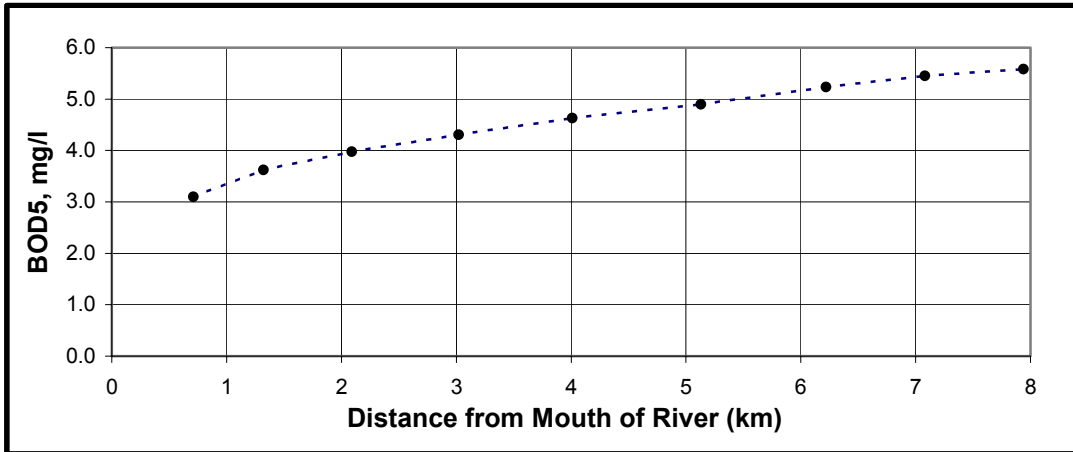
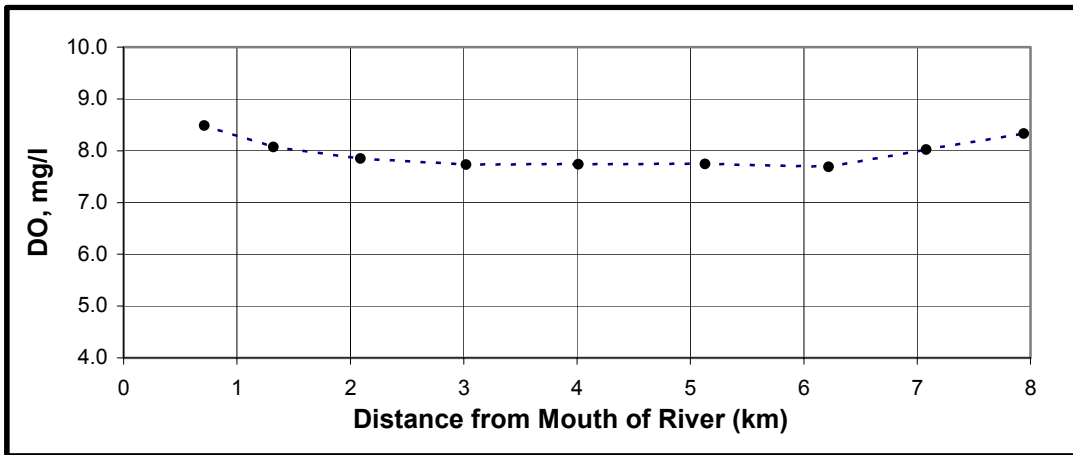

Figure A34: Ortho-Phosphorus vs. River Kilometer for the BLF

**Baseline Average Annual Condition Scenario (BAA)**



**Figure A35: BOD vs. River Kilometer for the (BAA)**



**Figure A36: Dissolved Oxygen vs. River Kilometer for the BAA**

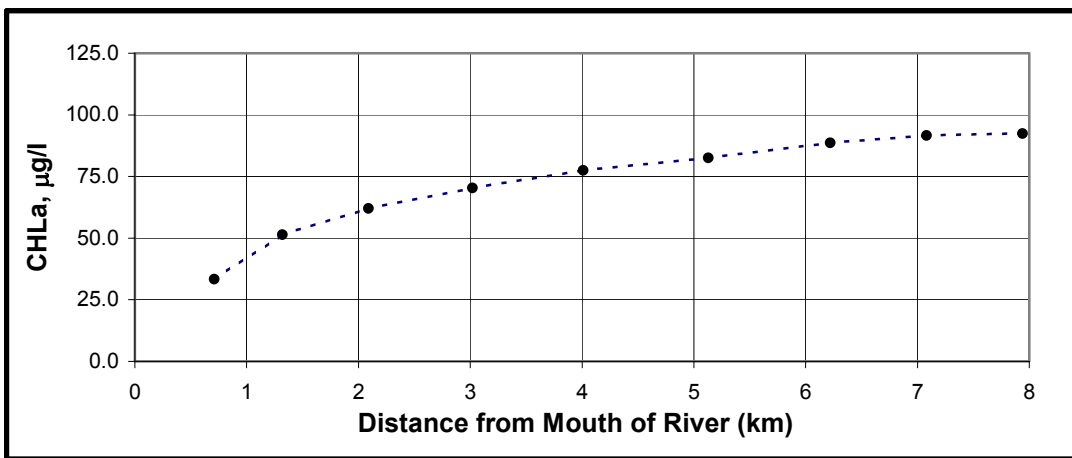

**Figure A37: Chlorophyll a vs. River Kilometer for the BAA**

### Baseline Average Annual Condition Scenario (BAA)

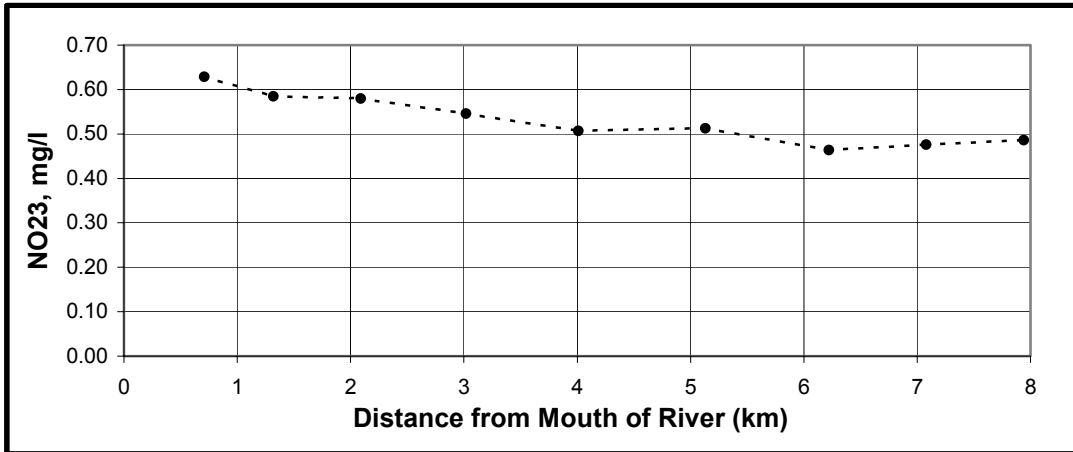

Figure A38: Nitrate (plus Nitrite) vs. River Kilometer for the BAA

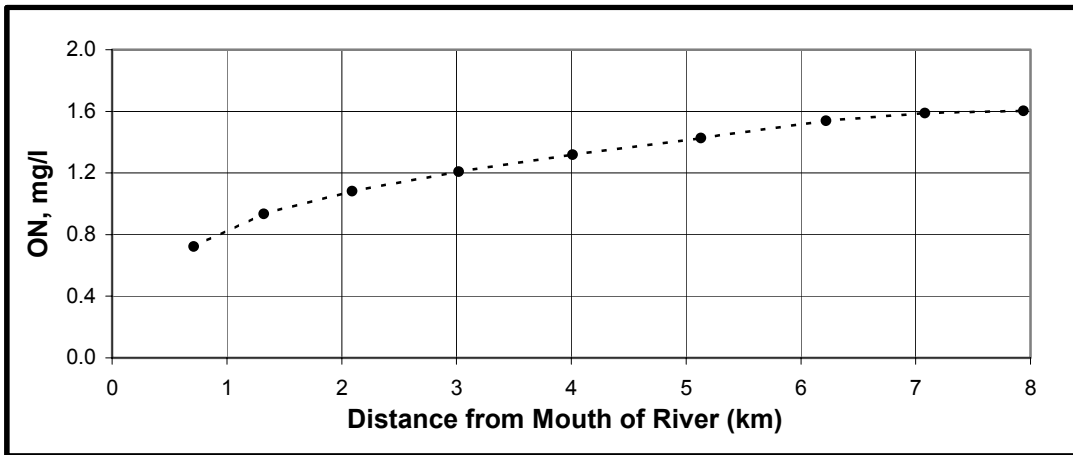

Figure A39: Organic Nitrogen vs. River Kilometer for the BAA

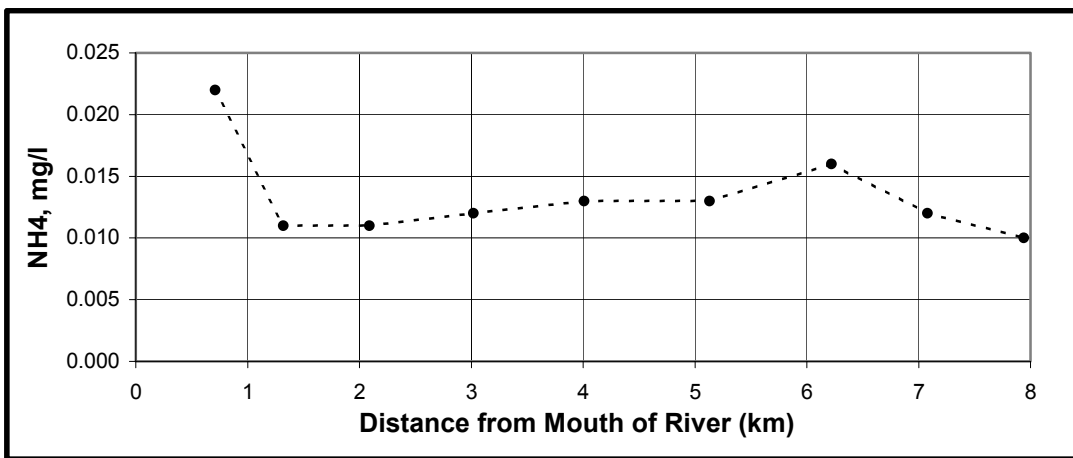

Figure A40: Ammonia vs. River Kilometer for the BAA

### Baseline Average Annual Condition Scenario (BAA)

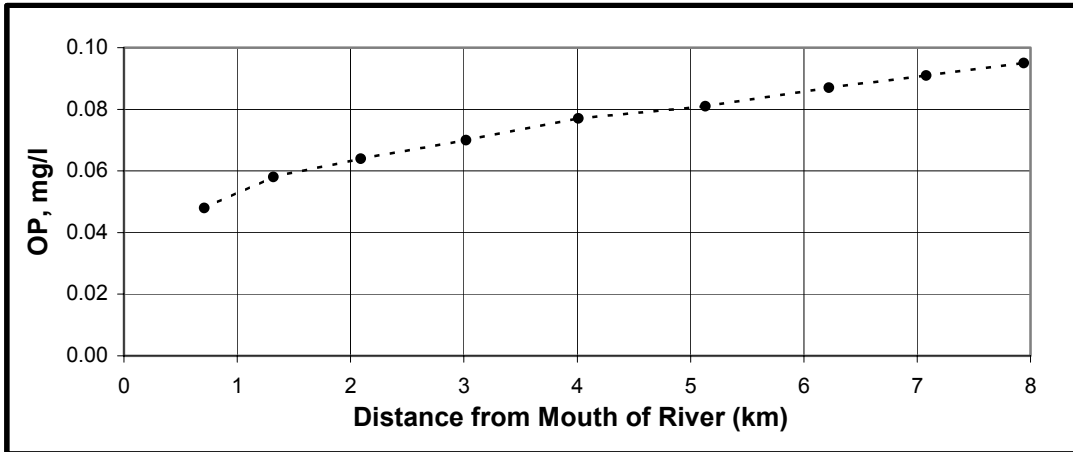

Figure A41: Organic Phosphorus vs. River Kilometer for the BAA

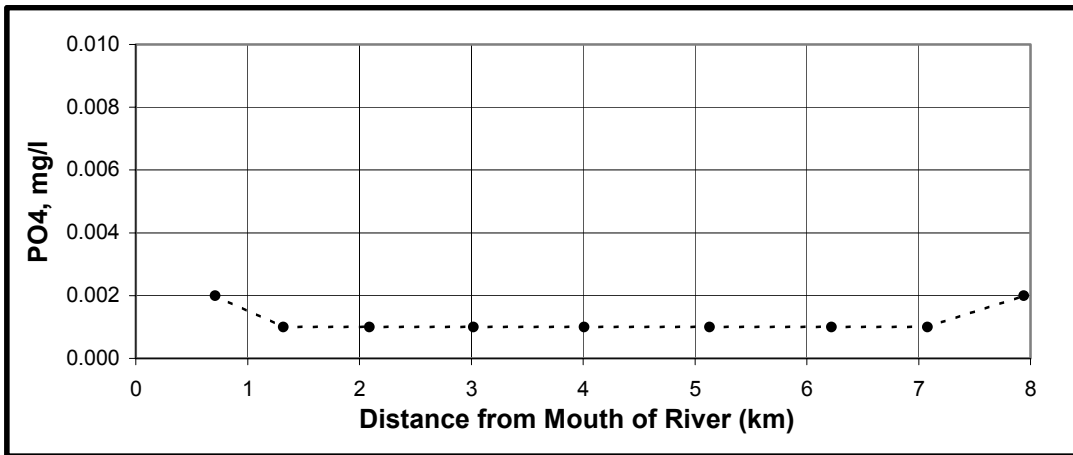

Figure A42: Ortho-Phosphorus vs. River Kilometer for the BAA

**Table A14: Nonpoint Source Concentration for the Low Flow Future Condition**

<b>Segment Number</b>	<b>NH4 mg/l</b>	<b>NO<sub>23</sub> mg/l</b>	<b>PO<sub>4</sub> mg/l</b>	<b>CHL <i>a</i> µg/l</b>	<b>CBOD mg/l</b>	<b>DO mg/l</b>	<b>ON mg/l</b>	<b>OP mg/l</b>
3	0.0409	0.8123	0.0274	1.00	2.67	6.60	0.1801	0.0151
4	0.0409	0.8123	0.0274	1.00	2.67	6.60	0.1801	0.0151
6	0.0409	0.8123	0.0274	1.00	2.67	6.60	0.1801	0.0151
7	0.0409	0.8123	0.0274	1.00	2.67	6.60	0.1801	0.0151
8	0.0409	0.8123	0.0274	1.00	2.67	6.60	0.1801	0.0151
9	0.0018	0.0058	0.0054	40.06	12.67	8.90	0.8862	0.0530

**Table A15: Nonpoint Source Concentration for the Average Annual Future Condition**

<b>Segment Number</b>	<b>NH4 mg/l</b>	<b>NO<sub>23</sub> mg/l</b>	<b>PO<sub>4</sub> mg/l</b>	<b>CHL <i>a</i> µg/l</b>	<b>CBOD mg/l</b>	<b>DO mg/l</b>	<b>ON mg/l</b>	<b>OP mg/l</b>
3	0.0272	0.9519	0.0218	6.11	4.82	9.31	0.2907	0.0169
4	0.0272	0.9519	0.0218	6.16	4.82	9.31	0.2907	0.0169
6	0.0272	0.9519	0.0218	6.11	4.82	9.31	0.2907	0.0169
7	0.0272	0.9519	0.0218	6.03	4.82	9.31	0.2907	0.0169
8	0.0272	0.9519	0.0218	6.00	4.82	9.31	0.2907	0.0169
9	0.0239	0.5925	0.0215	20.68	7.75	9.45	0.4617	0.0349

### Future Low Flow TMDL Scenario Results

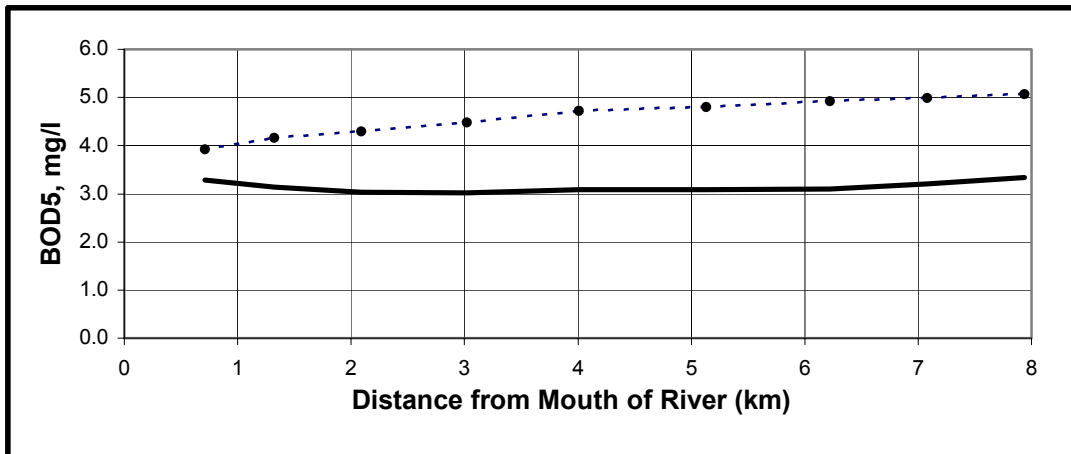

Figure A43: BOD vs. River Kilometer for the Future Low flow TMDL Scenario

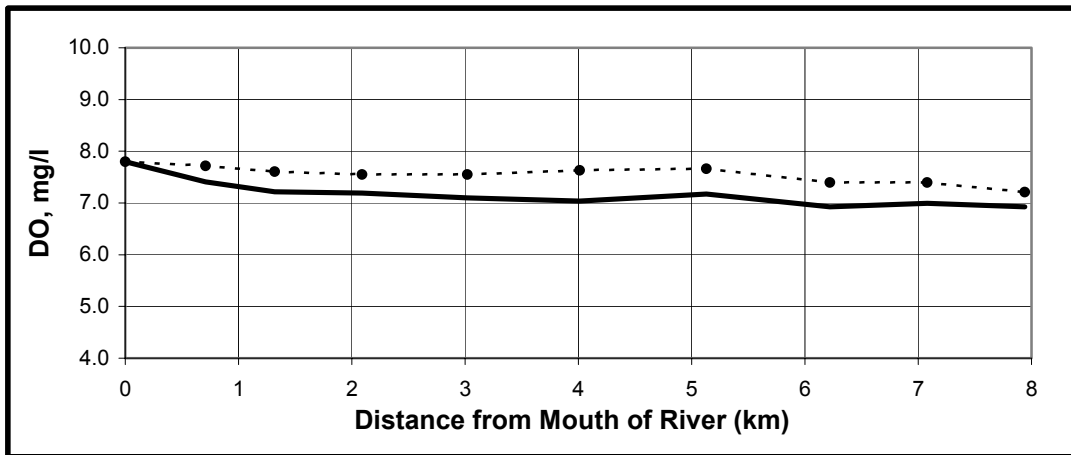

Figure A44: Dissolved Oxygen vs. River Kilometer for the Future Low Flow TMDL Scenario

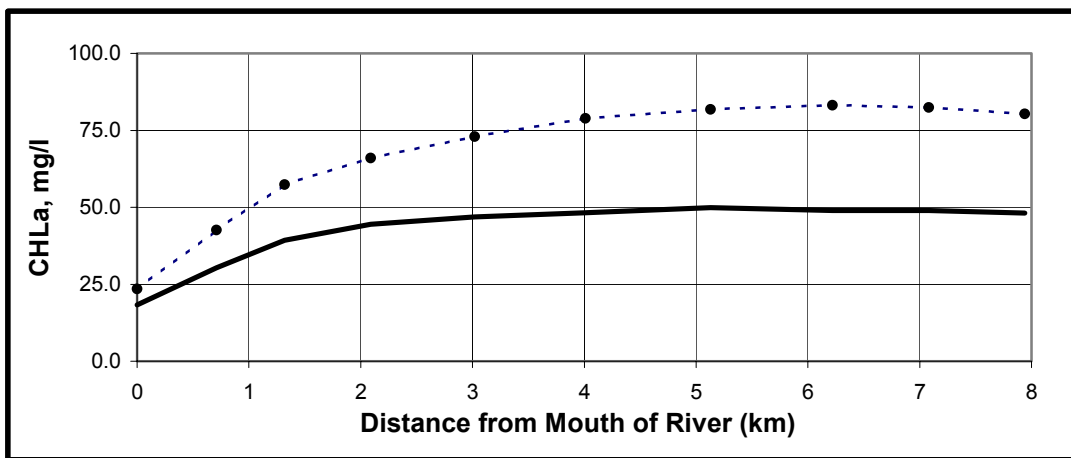

Figure A45: Chlorophyll a vs. River Kilometer for the Future Low Flow TMDL Scenario

----- Baseline Low Flow Condition Scenario      — Future Low Flow TMDL Scenario



### Future Low Flow TMDL Scenario Results

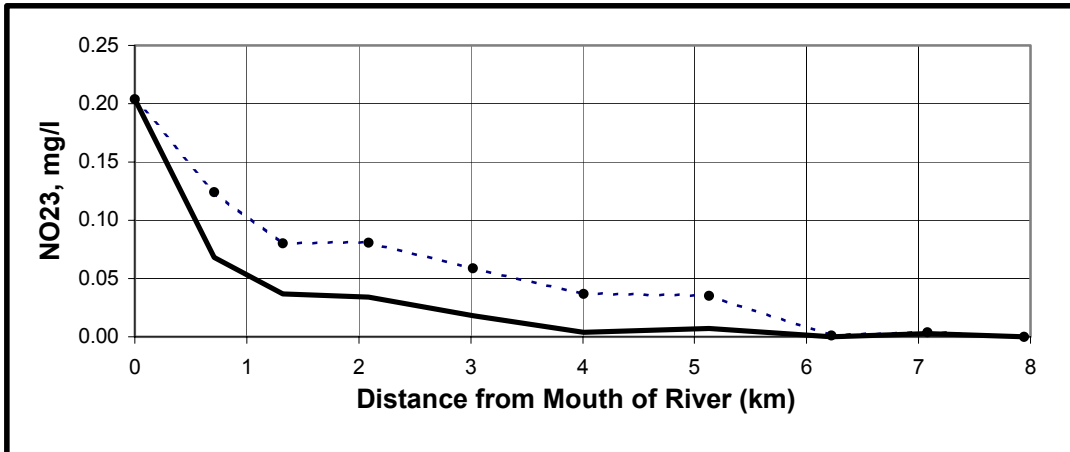

Figure A46: Nitrate (plus Nitrite) vs. River Kilometer for the Future Low Flow TMDL Scenario

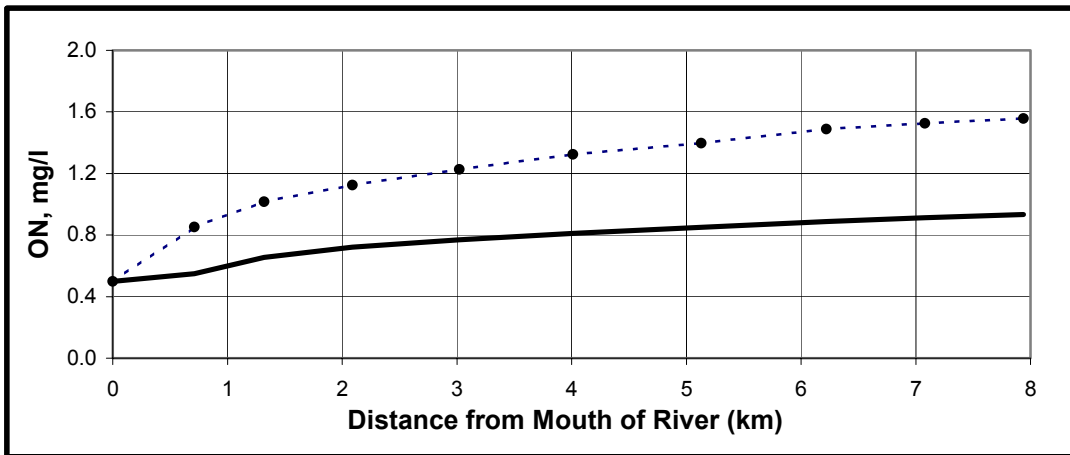

Figure A47: Organic Nitrogen vs. River Kilometer for the Future Low Flow TMDL Scenario

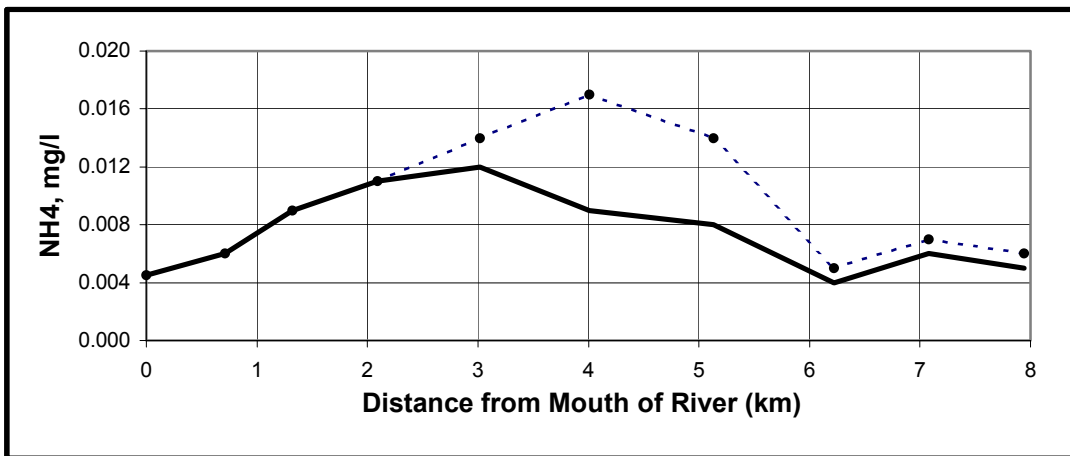

Figure A48: Ammonia vs. River Kilometer for the Future Low Flow TMDL Scenario

----- Baseline Low Flow Condition Scenario      — Future Low Flow TMDL Scenario

### Future Low Flow TMDL Scenario Results

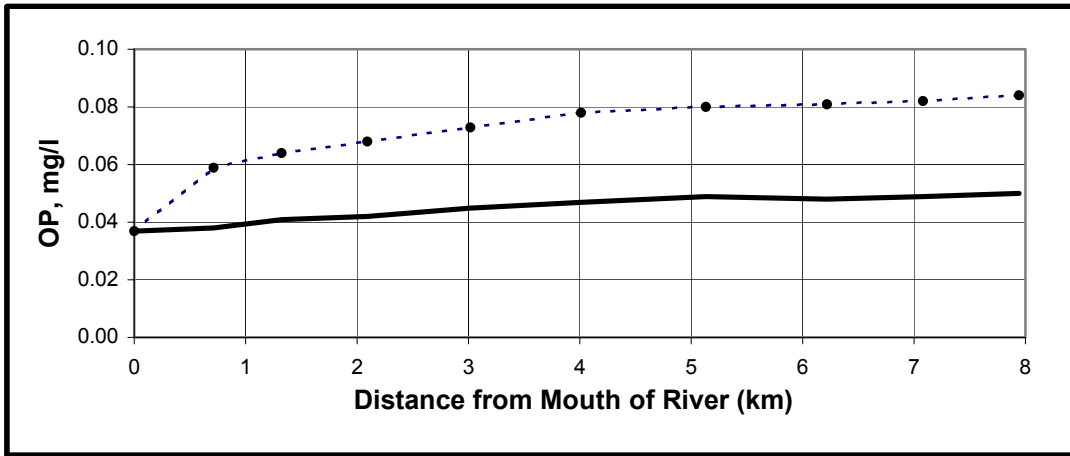

Figure A49: Organic Phosphorus vs. River Kilometer for the Future Low Flow TMDL Scenario

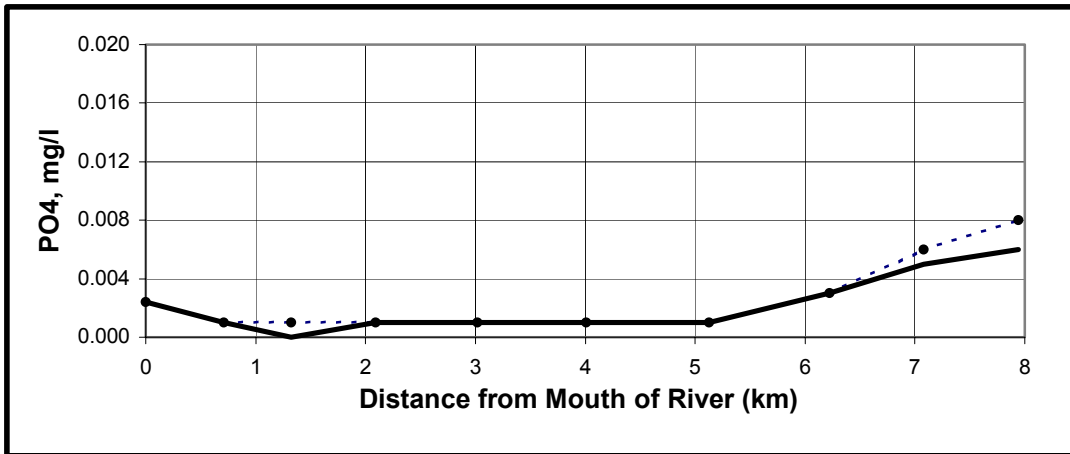
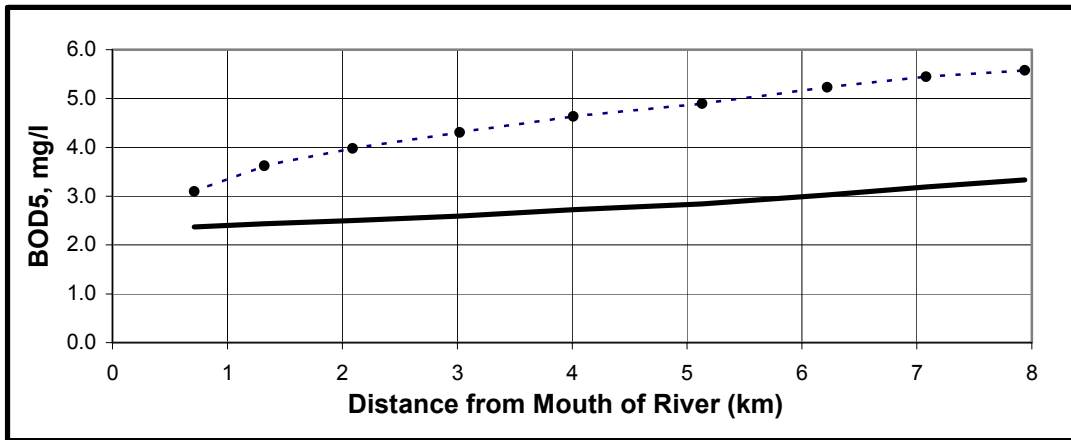

Figure A50: Ortho-Phosphate vs. River Mile for the Future Low Flow TMDL Scenario

----- Baseline Low Flow Condition Scenario      — Future Low Flow TMDL Scenario

**Future Average Annual Flow TMDL Scenario Results**



**Figure A51: BOD vs. River Kilometer for the Future Average Annual Flow TMDL Scenario**

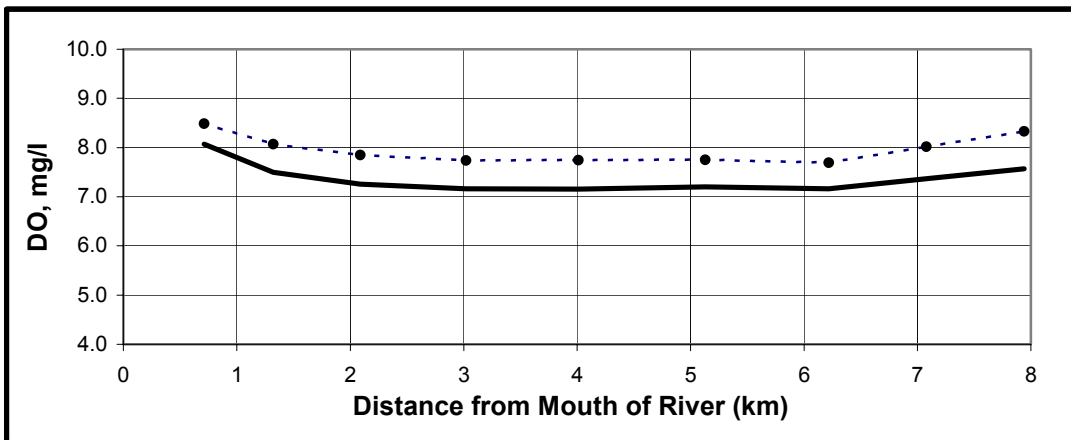

**Figure A52: Dissolved Oxygen vs. River Kilometer for the Future Average Annual Flow TMDL Scenario**

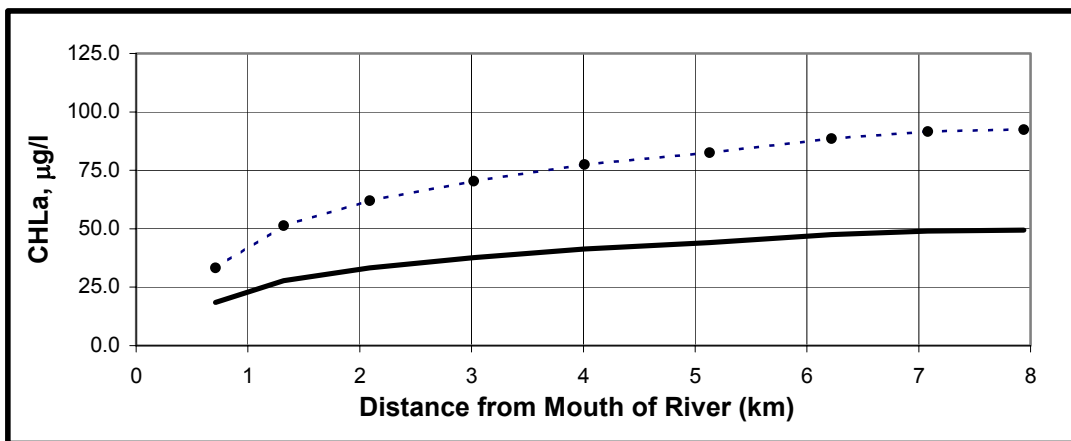

**Figure A53: Chlorophyll a vs. River Kilometer for the Future Average Flow TMDL Scenario**

----- Baseline Average Flow Condition Scenario ——— Future Average Flow TMDL Scenario

### Future Average Flow TMDL Scenario Results

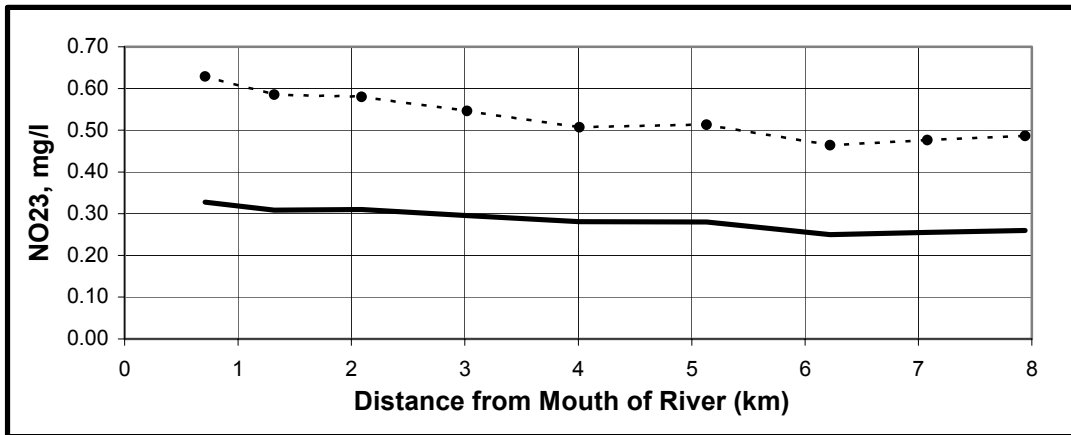

Figure A54: Nitrate (plus Nitrite) vs. River Kilometer for the Future Average Flow TMDL Scenario

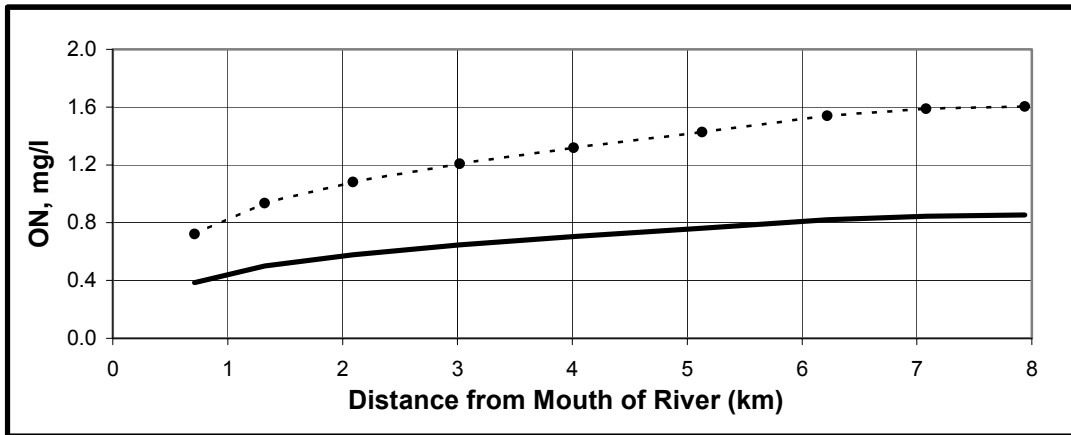

Figure A55: Organic Nitrogen vs. River Kilometer for the Future Average Flow TMDL Scenario

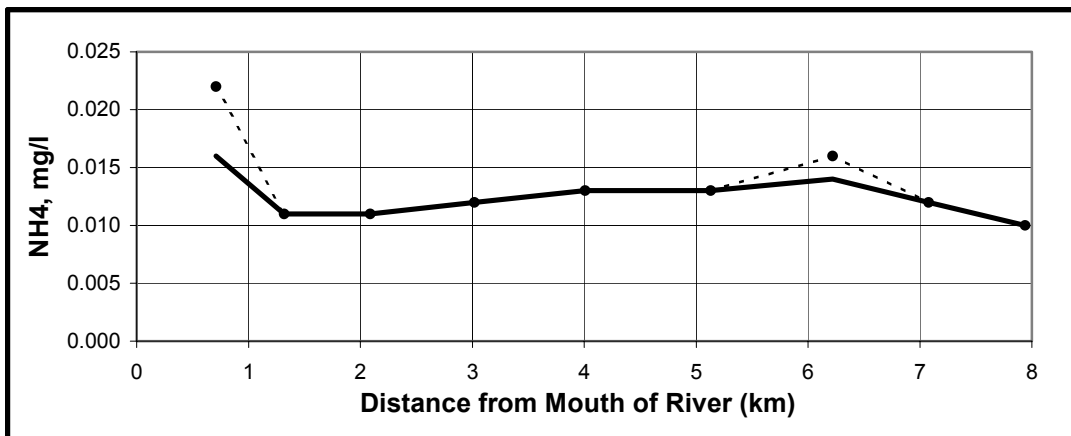

Figure A56: Ammonia vs. River Kilometer for the Future Average Flow TMDL Scenario

----- Baseline Average Flow Condition Scenario ——— Future Average Flow TMDL Scenario

### Future Low Flow TMDL Scenario Results

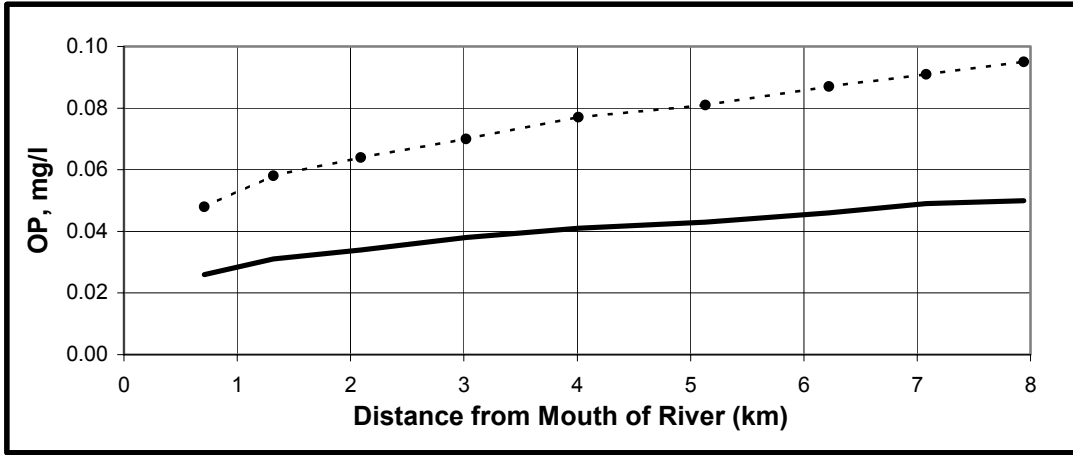

Figure A57: Organic Phosphorus vs. River Kilometer for the Future Average Flow TMDL Scenario

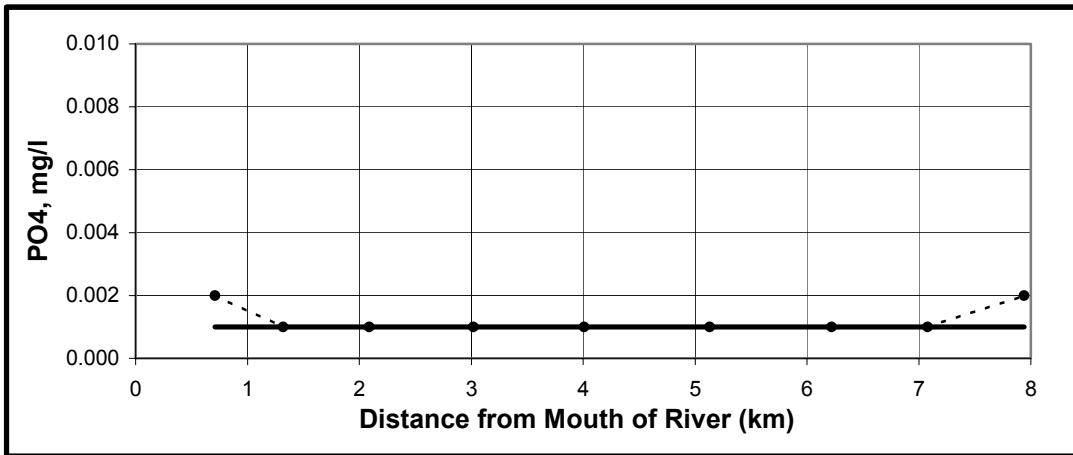

Figure A58: Ortho-Phosphate vs. River Kilometer for the Future Average Flow TMDL Scenario

----- Baseline Average Flow Condition Scenario ——— Future Average Flow TMDL Scenario

**Calculation of the Estimated Changes in Nutrient Loadings due to Land Use (LU) Changes  
Over a 6-year Time Span**

Estimation for acreage gain/loss on Northeast River watershed due to land use conversion:

Land Use	Gain/Loss		Gain/Loss (acres)	Average Annual Gain/Loss (acres/yr)
	From (acres)	To (acres)		
Urban	6,392	8,035	+1,643	+274
Forest	19,235	18,709	-526	-88
Agriculture	19,720	18,680	-1,040	-173

Nutrient Loading coefficients (based on MDE observed 1999 data and CBP V4.3)

Land Use	N (lbs/acre/yr)	P (lbs/acre/yr)
Urban	10.11	0.38
Forest	0.89	0.01
Agriculture	6.72	0.40

Estimation of annual nutrient load gained due to land use conversion:

Apply above loading coefficients to the average annual acreage gained or lost.

**For Nitrogen** =  $(274 \times 10.11) - (88 \times 0.89) - (173 \times 6.72)$   
=  $2,770.1 - 78.3 - 1,162.6 = \mathbf{1,530 \text{ lbs/yr}}$  (compared to the FA for nitrogen in the  
Northeast River TMDL of 5,829 lbs/yr).

**For Phosphorus** =  $(274 \times 0.38) - (88 \times 0.01) - (173 \times 0.40)$   
=  $104.1 - 0.88 - 69.2 = \mathbf{34 \text{ lbs/yr}}$  (compared to the FA for phosphorus in the  
Northeast River TMDL of 276 lbs/yr).

## REFERENCES

- Ambrose, Robert B., Tim A. Wool, James A. Martin. "The Water Quality Analysis Simulation Program, Wasp5". Environmental Research Laboratory, Office Of Research And Development, U.S. Environmental Protection Agency. 1993.
- Cerco, Carl F. *Water Quality in a Virginia Potomac Embayment: Gunston Cove*. College of William and Mary, Virginia Institute of Marine Science, Gloucester Point, Virginia. April 1985.
- Cerco, Carl F., Johnson, Billy H., and Wang, Harry V. "*Tributary Refinements to the Chesapeake Bay Model*." U.S. Army Corps of Engineers, Engineer Research and Development Center. 2002.
- Cerco, Carl F. And Thomas M. Cole. "*Three-dimensional Eutrophication Model of the Chesapeake Bay*." U.S. Corps of Engineers, Waterways Experiment Station. 1994.
- Clark L. J., and S. E. Roesh, *Assessment of 1977 Water Quality Conditions in the Upper Potomac Estuary*. U.S. EPA Annapolis Field Office, Annapolis Maryland. EPA 903/9-78-008 1978.
- Di Toro, D.M., J.J. Fitzpatrick, and R.V. Thomann. *Documentation for Water Quality Analysis Simulation Program (WASP) and Model Verification Program (MVP)*. EPA/600/3-81-044. 1983.
- Domotor, Diana K., Michael S. Haire, Narendra N. Panday, and Harry V. Wang. *Mattawoman Creek Water Quality Model*. Technical Report No. 64, Maryland Department of the Environment, Water Management Administration, Modeling and Analysis Division. October 1987.
- Lung, W. S. *Water Quality Modeling of the Patuxent Estuary*. Final Report to the Maryland Department of the Environment, Water Management Administration, Chesapeake Bay and Special Projects Program, Baltimore, MD. 1993.
- Panday, Narendra N., and Michael S. Haire. *Water Quality Assessment of Mattawoman Creek and the Adjacent Potomac River: Summer 1985*. Technical Report No. 52, Water Management Administration, Modeling and Analysis Division, Maryland Office of Programs, Department of Health and Mental Hygiene. September 1986.
- Thomann, Robert V., John A. Mueller. *Principles of Surface Water Quality Modeling and Control*. HarperCollins Publisher Inc. New York. 1987.
- Thomann R. V., and J. J. Fitzpatrick. *Calibration and Verification of a Mathematical Model of the Eutrophication of the Potomac Estuary*. HydroQual, Inc. Final Report Prepared for the D.C. Department of Environmental Service. 1982.

FINAL

U.S. EPA Chesapeake Bay Program. *Chesapeake Bay Program: Watershed Model Application to Calculate Bay Nutrient Loadings: Final Findings and Recommendations* and Appendices. 1996.

U.S. EPA. *Technical Guidance Manual for Developing Total Maximum Daily Loads, Book 2: Streams and Rivers, Part 1: Biochemical Oxygen Demand Dissolved Oxygen and Regulations and Standards*, Washington, D.C. March. 1997.